



› 2023





# FISH FOR MORE

We don't care how good the view is – going home empty-handed is never an option. That's why every Minn Kota® is made to help you get more of what you came for. Fewer hang-ups, more hook-ups. Less to worry about, more to brag about. There's a reason anglers trust our name over any other on the water: when you fish with us, you fish for more.

## › TROLLING MOTORS

- 4** Buying Guide
- 10** Technologies
- 24** Freshwater Trolling Motors
- 34** Saltwater Trolling Motors
- 40** Trolling Motors Quick Comparison Chart

## › SHALLOW WATER ANCHORS

- 42** Shallow Water Anchors
- 48** Buying Guide

## › BATTERY CHARGERS

- 52** Battery Chargers
- 56** Buying Guide

## › ACCESSORIES

- 58** Rigging and Accessory Guide
- 62** Accessories
- 67** Apparel





# TROLLING MOTOR BUYING GUIDE

You learn a lot when you build 10 million motors. Like how to build one that lasts. One that makes your boat easier to control. One that takes the hassles and distractions out of an angler's hands so they can focus on what they're throwing out, what they're reeling in and what they came out here to do.

This guide is designed to help you find the right one. No matter the angler, no matter the situation, we've got a motor that's built tough and proven to perform.

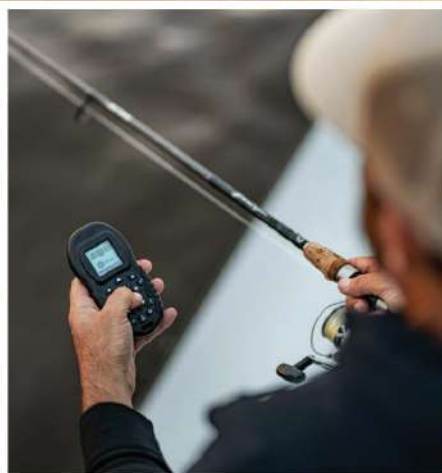

# FRESHWATER VS. SALTWATER

Where you fish determines a lot. Every motor we build is tough as nails, but for saltwater anglers we layer on more corrosion protection. Our freshwater motors are all black, while our saltwater motors are white and feature the Riptide® name.

## TROLLING MOTORS WITH A TRACK RECORD

For 85 years. Over 10 million motors. We've built trolling motors the right way, from the inside out. It all starts with a powerful core of rock-solid innovations.

### Unflinching Toughness

Our ultra-high-yield composite shaft is virtually indestructible, flexes on impact, and won't break, rust, kink or corrode. It's proven on the water. And **guaranteed for life**.



### Silent Operation

We've spent decades dialing in absolute stealth operation on every motor. The entire lower unit is designed to dissipate heat while a unique bearing system cuts friction to virtually silence all moving parts. Every day.



### Reliable Power

Our props make short work of weed fields and anything else that gets in your way – without battery-draining chopping and hacking. That's unrelenting power that you can count on.



## THE RIPTIDE® DIFFERENCE

From the inside out, Riptide motors are designed to stop saltwater corrosion dead in its tracks.

### Coated Lower Units

Riptide lower unit housings are grit-blasted, then coated in aluminum to prevent oxidization and rust. Then, a final layer of powder coat paint provides the ultimate protection.

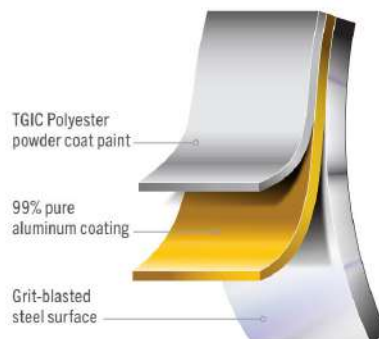

### Fully Encapsulated Electronics

Riptide control boards and circuitry are protected by a layer of marine-grade urethane. And all electrical connections are sealed with liquid-tight heat shrink tubing to keep saltwater out, no matter what.



UNPROTECTED      PROTECTED



# 2 MOUNTING LOCATIONS

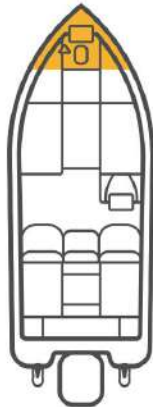

## BOW

Bow-mount trolling motors are packed with everything from stump-busting toughness to GPS-powered precision boat control. They attach to the front of the boat with a mount, and pull the boat through the water for better maneuverability and control.

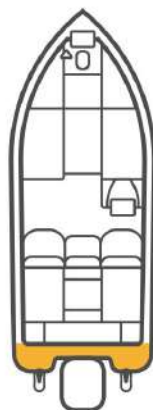

## TRANSOM

Our transom-mount trolling motors are trusted, reliable workhorses. They mount to the back of the boat with a clamp-on bracket and are controlled with a hand tiller. Ideal for smaller boats, dinghies and canoes, they're great for general positioning and basic trolling.



# MOTOR SIZE

To choose a trolling motor, determine how much power you need (thrust level and voltage) and what size shaft you need.

## Thrust

How much power do you need? Trolling motor power is measured in pounds of thrust, and boat weight is key when determining how much thrust you need.

## Voltage

Our trolling motors require one to three batteries on your boat based on their power level. You'll need one battery for every 12 volts in your trolling system.

USE THIS CHART TO HELP DETERMINE HOW MUCH POWER YOU NEED.

BOAT WEIGHT (LB)	MAX BOAT LENGTH (FT)	RECOMMENDED MINIMUM THRUST LEVEL (LB OF THRUST)	BATTERIES NEEDED
1,500 or less	14'	30	1 battery (12v)
2,000	17'-18'	40-45	1 battery (12v)
2,500	20'-21'	50-55	1 battery (12v)
3,000-3,500	23'	70	2 batteries (24v)
4,000	25'	80	2 batteries (24v)
4,500 or more	25'+	101-112	3 batteries (36v)

## SHAFT LENGTH

Choosing the proper shaft length is important; if it's too short, the prop won't be sufficiently submerged. We recommend submerging the center of the motor section at least 12 inches.\*

### Bow Guide

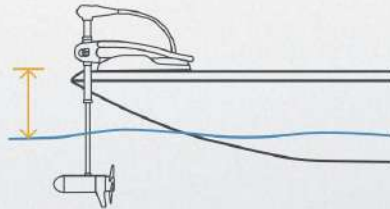

BOW TO WATERLINE	RECOMMENDED SHAFT LENGTH
0" to 10"	36"
16"-22"	42"-45"
22"-28"	48"-52"
28"-34"	54"-62"
34"-44"	72"
45"+	87"

### Transom Guide

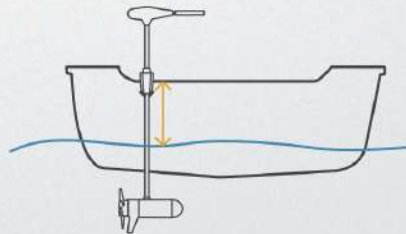

TRANSOM TO WATERLINE	RECOMMENDED SHAFT LENGTH
0"-10"	30"
10"-16"	36"
16"-22"	42"
Over 22"	Consult Factory

NOTE: For rougher water conditions, a longer shaft may be needed.

\* Add 5" to waterline measurement for fishing in rough water. Optimal operating mode is with engine trimmed all the way down. Add 9" for bow-mount Hand Control motors. We recommend that the propeller tip is submerged at least 12" below the water line to avoid churning or agitation of water surface.

# MOTOR CONTROL

Different motors have different control styles, each with their own unique advantages.



## ▶ ELECTRIC-STEER BOW-MOUNT MOTORS

Innovative and intuitive, these models offer more control options and technology like Spot-Lock. With available i-Pilot™ and i-Pilot Link™ systems, you can spend less time messing with your boat and more time fishing.



### Electric-Steer Foot Pedal

Electric-steer motors give you the option to use a wireless remote control or the more traditional foot pedal. The Ulterra® foot pedal also lets you stow and deploy the motor automatically.



## ▶ CABLE-STEER BOW-MOUNT MOTORS

Rugged and responsive, these models rely on a cable as the direct link between the foot pedal and the motor. Popular with bass fishermen, they also excel in shallow water by providing extra protection from things like weeds and stumps.



### Cable-Steer Foot Pedal

Foot pedals for cable-steer motors are even more responsive, and are made with high-impact composite materials.



## ▶ HAND CONTROL MOTORS

These models feature a tiller for direct, hands-on control of trusted Minn Kota power, delivering precise maneuverability. Hand control is available on all transom mounts, and as an option on most cable-steer models.



# CAN'T CHOOSE ELECTRIC VS. CABLE? THEN CHOOSE ULTREX.

Our Ultrex™ bow-mount trolling motor combines responsive control with advanced GPS features – meaning you get Power Steering and features like Spot-Lock® all in one package. There's a reason it's the most popular and dominant bow-mount on the water.



## CHOOSING YOUR MOTOR

Once you know the basics you're looking for – mounting location, size and control style – the decision comes down to which technologies matter to you. The next few pages walk you through our technologies and the motors featuring them, so you can find the right one for you.

# GET THE HOOK UP

## MORE CONNECTION, MORE CAPABILITY

 SHALLOW WATER ANCHORS

 I-PILOT LINK GPS SYSTEMS

 FISH FINDER IN DASH

 SHALLOW WATER ANCHOR FOOT SWITCH

 TROLLING MOTOR FOOT PEDAL

 FISH FINDER IN BOW

 TROLLING MOTOR

 MOBILE APPS



 SHALLOW WATER ANCHOR REMOTES





 **ONE-BOAT**  
NETWORK®

Want more of your time on the water? We know the feeling. It's why we developed the One-Boat Network®. And now, there's no limit to where we can take you. Get on fish. Stay on fish. And put fish in the boat.

Minn Kota and Humminbird® are one team, and the One-Boat Network is born from our commitment to making the most advanced fishing gear even better, by making it work together. That means One-Boat Network-capable products are easy to connect and simple to use, unlocking more features, capabilities and potential for anglers everywhere. Because when you fish with us, you fish for more.

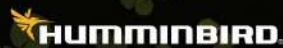

SCAN TO  
LEARN MORE



# LET YOUR MOTOR DRIVE THE BOAT FOR YOU

When you stop messing with your boat, you start catching more fish. That's why both i-Pilot and i-Pilot Link use GPS to control your boat for you – keeping you on a spot, retracing a path and more. You just push a button, and the motor takes care of the rest.

## WHAT'S THE DIFFERENCE BETWEEN i-PILOT AND i-PILOT LINK?

i-Pilot Link connects your trolling motor to your Humminbird fish finder, unlocking even more boat control features than i-Pilot and allowing you to control your motor from your Humminbird.



**i-PILOT<sup>®</sup>**  
LINK<sup>™</sup>



**i-PILOT<sup>®</sup>**

### AVAILABLE ON:

The following motors come with your choice of i-Pilot or i-Pilot Link.

Ultrex | Ulterra | Terrova  
PowerDrive\* | Riptide Ulterra  
Riptide Terrova | Riptide PowerDrive\*

\* Only available with i-Pilot



## i-PILOT LINK

i-Pilot Link's remote brings intuitive touchscreen command to a huge, full-color LCD display with a customizable home screen.

### FEATURES

<b>SPOT-LOCK</b>	<b>2,500 SPOTS</b>
JOG	✓
<b>ADVANCED AUTOPILOT</b>	✓
<b>GO TO</b>	✓
<b>CRUISE CONTROL</b>	✓
<b>SPEED AND STEERING</b>	✓
<b>PHONE APP</b>	✓
<b>ITRACKS</b>	<b>66 ITRACKS</b>
ITRACK OFFSET	✓
BACKTRACK	✓
<b>FOLLOW</b>	✓
FOLLOW OFFSET	✓
<b>CIRCLE MODE</b>	✓
<b>HUMMINBIRD INTEGRATION</b>	✓



SCAN TO  
LEARN MORE

**IN ADDITION TO THE REMOTE, i-PILOT™ AND i-PILOT LINK™ CAN BE ACTIVATED FROM ANYWHERE IN THE BOAT.**



**Micro Remote**

Add this remote to your system for quick command of speed, steering, Spot-Lock and Advanced AutoPilot™.



**Mobile Apps**

Available for Apple® or Android™ devices, our i-Pilot and i-Pilot Link apps let you control speed, steering, Spot-Lock and Advanced AutoPilot. It also lets you easily update your i-Pilot or i-Pilot Link software.



**Humminbird® Virtual i-Pilot Link Remote**

i-Pilot Link's Humminbird integration gives you a virtual remote on your Humminbird screen that lets you control speed, steering, Spot-Lock and Advanced AutoPilot – directly from your fish finder.

**i-PILOT**

With a large LCD screen and intuitive controls, the i-Pilot remote is easy to use on day one and lets you see everything your motor is doing in real time.

**NOTE:** i-Pilot does not connect to a Humminbird fish finder. i-Pilot Link does.

FEATURES	
<b>SPOT-LOCK</b>	<b>16 SPOTS</b>
JOB	✓
<b>ADVANCED AUTOPILOT</b>	✓
<b>GO TO</b>	✓
<b>CRUISE CONTROL</b>	✓
<b>SPEED AND STEERING</b>	✓
<b>PHONE APP</b>	✓
<b>ITRACKS</b>	<b>16 ITRACKS</b>



SCAN TO LEARN MORE



Both i-Pilot and i-Pilot Link feature Minn Kota's



**WARRANTY**

## WHAT CAN I DO WITH GPS IN MY MOTOR? GLAD YOU ASKED.

With i-Pilot or i-Pilot Link on your boat, you become an unstoppable force. Get to fish. Stay on fish. Catch fish. All automatically, all with GPS accuracy. It's less a question of what can i-Pilot and i-Pilot Link do, and more a question of what can't they do?



**i-PILOT**  
LINK™



**i-PILOT**®

### Advanced AutoPilot™

Point the motor where you want to go and hit the button. Your motor will automatically keep you on that heading.

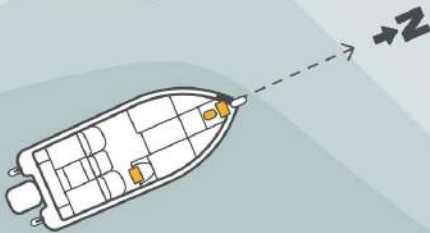

### Spot-Lock®

Anchor down on any spot with GPS accuracy.



### iTracks LINK

Save a trolling path by either recording it at the start, saving it after you're done trolling (**BackTracks**), or stringing together waypoints and Spot-Locks (**Routes**).



LINK Indicates an i-Pilot Link exclusive feature.

\* This feature requires Humminbird LakeMaster® Charts or AutoChart® Live.

### Circle Mode LINK

Cast to a spot while orbiting in a circle around it.

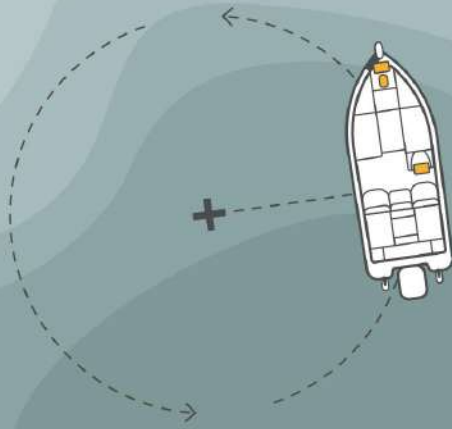

### Follow\* LINK

Choose a contour – depth, bottom hardness or vegetation – on your Humminbird and your motor will automatically drive you along it.

### Backtrack LINK

Turn your Humminbird current track into an iTrack. i-Pilot Link will automatically retrace it up to 2 miles. You can dial-in your BackTrack travel distance in 0.1 mile increments.

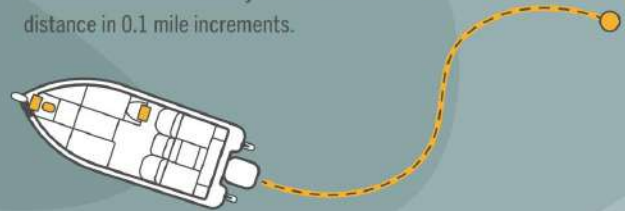

### Go To

i-Pilot and i-Pilot Link can drive your boat for you. From your remote, mobile app or Humminbird unit (on i-Pilot Link), select any Spot-Lock, Route, waypoint, iTrack or contour, and your motor will drive your boat to it automatically.

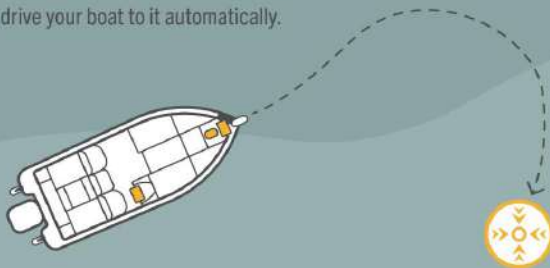

### Speed and Steering

Both GPS systems give you command of speed, steering and Cruise Control that you can adjust in 0.1 mile-per-hour increments.



### Part of the One-Boat Network®

i-Pilot Link connects your trolling motor to your Humminbird fish finder to unlock exclusive features like Follow and Circle Mode, and gives you the ability to control your motor directly from your Humminbird.

**NOTE:** Many i-Pilot Link functions still work without a connected Humminbird fish finder.

# SPOT-LOCK

THE MOST ACCURATE  
GPS ANCHOR EVER



“ABSOLUTE GAME CHANGER! SET IT AND FORGET IT, MORE TIME  
TO FISH WITHOUT CONSTANTLY HAVING TO BE ON THE PEDAL.”

— FISHHOG



# THIS IS YOUR SPOT

The most popular button on your fishing remote. The one with the anchor on it. That's Spot-Lock, the game-changing GPS anchor. Just push it, and Spot-Lock uses GPS to lock your boat onto your fishing spot more accurately than anything else on the water.



## SPOT-LOCK



SCAN TO LEARN MORE

### Distance to Spot

The "Distance to Spot" reading on the remote tells you how close you are to your set Spot-Lock.

### Spot-Lock Jog

The heading sensor on i-Pilot and i-Pilot Link lets you move your spot five feet forward, backward, left or right – just by pushing a button.

### Unrivaled Accuracy

Advanced hardware and software algorithms mean Spot-Lock can hold you on a spot more accurately than ever before.

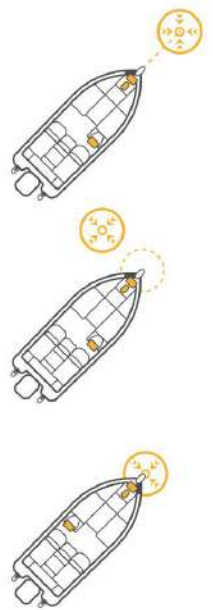

### Lock Down From Anywhere



MINN KOTA MOTOR FOOT PEDAL

HUMMINBIRD FISH FINDERS

i-PILOT REMOTE  
i-PILOT LINK REMOTE  
PHONE APP  
MICRO REMOTE



# LOCK ON. FISH ON.

Take aim with absolute confidence – and complete boat control. A new accessory from our co-anglers at Humminbird, MEGA Live Imaging® TargetLock™ offers the crystal clear, real-time views of MEGA Live Imaging with the ability to lock on to structure at the push of a button, even while your boat is moving or anchored using Minn Kota Spot-Lock. That means you'll never again have to choose between Live Sonar and Spot-Lock, two of fishing's most powerful technologies. It's almost unfair. Almost. TargetLock is only for Minn Kota Ultrex, and only on the One-Boat Network.

MEGA **LIVE** IMAGING™  
TARGETLOCK™



SCAN TO  
LEARN MORE



# NEVER CHOOSE BETWEEN LIVE SONAR AND SPOT-LOCK

No more trade-offs. MEGA Live Imaging TargetLock lets you lock in absolutely clear, real-time returns of structure, while unleashing the full boat control capability of Minn Kota Ultrex, starting with Spot-Lock. But you also get a full arsenal of other features designed to help you locate, stay on and catch more fish.



### TargetLock™

Lock your MEGA Live view onto fish-holding structure, whether your boat is moving or anchored using Minn Kota Spot-Lock.



### MEGA Live Sweep

Get an automatic, constantly updated, 120° view of structure and fish – no matter where your trolling motor is pointed.

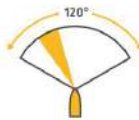

### Minn Kota Steer

Control both your trolling motor and the MEGA Live transducer at the same time using the foot pedal of your i-Pilot Link Ultrex.



### One-Boat Network Button

This programmable softkey lets you activate MEGA Live Sweep Mode, Minn Kota Steer or set a waypoint on your Humminbird chart – with even more capabilities on the way.



## ONLY AVAILABLE ON ULTREX.

MEGA Live TargetLock easily mounts to Ultrex for full use of the most capable motor in the sport.

See additional accessories on page 60.



## NOW SHOWING ON A SCREEN NEAR YOU.

See fish in real time – in no time. Attach the MEGA Live Imaging TargetLock accessory to your Ultrex trolling motor using one of our mounting brackets and connect to a compatible Humminbird fish finder. Simple as that.



Foot Pedal



Optional Hand Remote

# YOUR MOTOR'S FINDING FISH LEFT AND RIGHT



**BUILT-IN  
MEGA SI**



**BUILT-IN  
MEGA DI**

## Humminbird MEGA Side and Down Imaging®. Built into Your Minn Kota®.

Put more MEGA in your motor, with a Humminbird MEGA Imaging® transducer built right into the lower unit. Available with MEGA Side and MEGA Down Imaging®, you get the clearest images of what's below beamed directly to your Humminbird fish finder – with no cluttered wires, no clamps and a fully protected transducer.

### MEGA Imaging®

MEGA Imaging gives you the clearest images of the water below. Only from Humminbird.

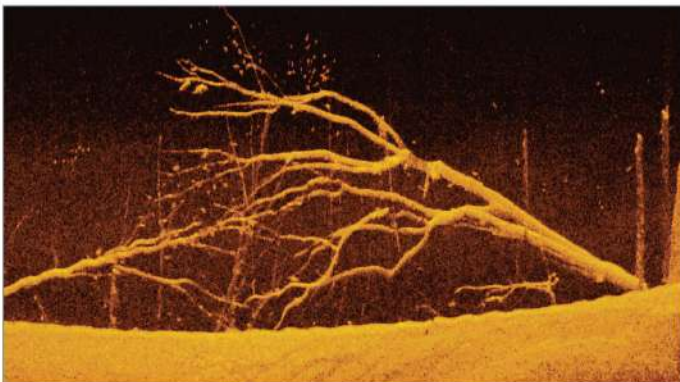

### Built-In vs. External

Built-In MEGA Imaging brings the wiring and transducer into the lower unit to keep it protected and out of your way.





SCAN TO  
LEARN MORE

**AVAILABLE ON:**

**MEGA Side and Down Imaging**

Ultrex | Ultrerra

**MEGA Down Imaging**

Ultrex | Ultrerra | Terrova

Only Compatible with  
Humminbird on the  
One-Boat Network:



APEX\*



SOLIX\*



SELECT HELIX\* MODELS

**Dual Spectrum CHIRP 2D Sonar**

The integrated transducer also delivers Dual Spectrum CHIRP (2D sonar) with long fish arches and clear target separation.

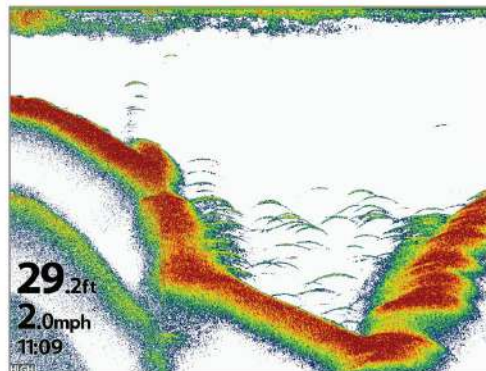

US | <sup>2</sup>

**Universal Sonar 2\***

Motors with Universal Sonar 2 put a 2D transducer in the lower unit with all wiring running through the shaft. It's clean, protected and can connect to most fish finder brands.

\* Available on Ultrex, Ultrerra, Terrova, Fortrex and PowerDrive.

# HOW TO BUILD A BETTER MOTOR

When you build 10 million motors, you learn a thing or two about how to make them tougher, longer-lasting and easier to use.



## › Digital Maximizer™

Traditionally, trolling motors gave you five speeds to choose from. But our Digital Maximizer™ technology creates variable speed motors, so you can dial in the right pace and your motor will only use as much power as you need, giving you up to five times longer on the water.

### STANDARD ON:

Ultrix | Ultrerra | Terrova | Fortrex | PowerDrive  
Riptide Ultrerra | Riptide Terrova | Riptide Fortrex  
Riptide PowerDrive | Endura Max | Traxis

### AVAILABLE ON:

Maxxum | PowerDrive Pontoon  
Riptide Maxxum | Riptide Transom



Terrova



Ultrix | Fortrex

## › Lift-Assist

Some motors are designed to be easier to get in and out of the water, cutting the weight of stow and deploy as much as 50%.

### STANDARD ON:

Ultrix | Fortrex | Terrova | Riptide Fortrex | Riptide Terrova



## › Bowguard 360°

This rugged, quiet mount breaks away on impact and then automatically resets itself for uninterrupted fishing. And on Fortrex, the mount is even removable.

### STANDARD ON:

Fortrex | Maxxum | Riptide Fortrex

### AVAILABLE ON:

Riptide Maxxum



## › Auto Stow/Deploy and Power Trim

Push-button stow, deploy and trim come standard on Ultrerra and Riptide Ultrerra to make it easier than ever to get in, get out and go anywhere.

### STANDARD ON:

Ultrerra | Riptide Ultrerra



# CONTROL TECHNOLOGIES

## Hand Tillers

Get a better handle on motor control with our tiller handles, which are each designed to make fishing easy and comfortable.

### Telescoping Tiller

Extends up to 6" for versatile fishing.

**STANDARD ON:**  
Endura | Endura Max



### Tilt / Extend Tillers

Tilts up to 45° and extends up to 6" for effortless command.

**STANDARD ON:**  
Traxis | Riptide Fortrex  
Riptide Maxxum | Riptide Transon

**AVAILABLE ON:**  
Edge



### Tilt Twist Tiller™

Features an ergonomic grip for easy control of steering.

**STANDARD ON:**  
PowerDrive Pontoon



## CoPilot™

This compact wireless remote is waterproof and gives you basic command of your motor. On Terrova, it adds high speed bypass and AutoPilot activation. Available as an accessory.



CoPilot for PowerDrive

### AVAILABLE ON:

PowerDrive | PowerDrive Pontoon  
Riptide Terrova | Riptide PowerDrive

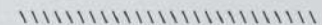



# FRESHWATER TROLLING MOTORS

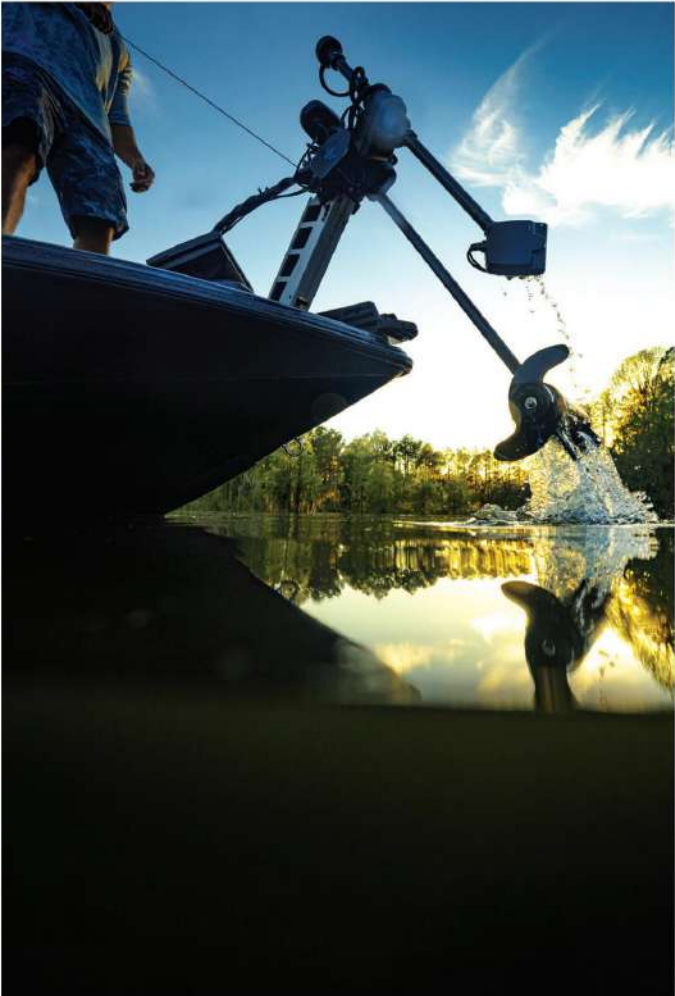
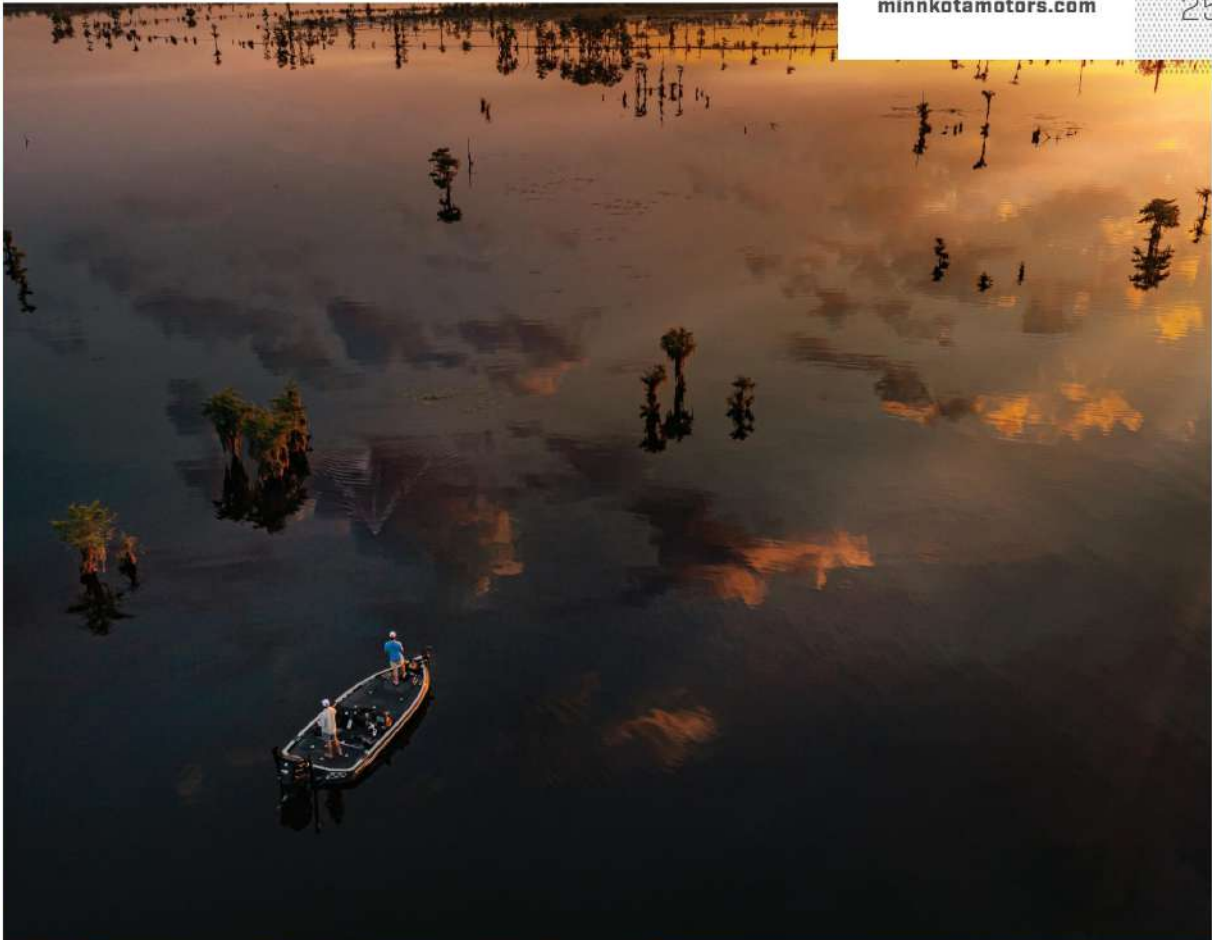

# ▶ ULTREX



SCAN TO LEARN MORE



Only Ultrex™ gives you ultra-responsive Power Steering for precise control to get to any fishing spot – and a Spot-Lock GPS anchor to hold you there no matter what. Plus, Lift-Assist for easy stow and deploy, and Steering Lock to keep your motor pointed in the direction you left it when you take your foot off the pedal.

- i-PILOT™\*
  - i-PILOT™ LINK\*
  - AUTOPILOT™
  - DIGITAL MAXIMIZER™
  - BUILT-IN™ MEGA™
  - BUILT-IN™ MEGA™
  - US|<sup>2</sup>™\*
  - SPOT-LOCK
  - 3 YEAR WARRANTY
- \* Available on select models.

**ONE-BOAT NETWORK™** Control Ultrex from your Humminbird fish finder with the One-Boat Network. See more on page 10.

## FEATURES

▶ Power Steering



▶ Steering Lock



▶ Lift-Assist



## CONTROL

i-Pilot or i-Pilot Link



Ultrex™ Foot Pedal



- Momentary On
- High-Impact Composite Material
- Speed Control
- Heel/Toe Steering
- Spot-Lock
- AutoPilot On/Off
- Constant On

## SPECS

Thrust Levels	80, 112
Shaft Lengths	45", 52", 60"
Prop	Weedless Wedge 2



# » FORTREX



Fortrex® features our most rugged, powerful mount. Its Mono-Arm Design is made of anodized aluminum, and the Removable Bowguard 360°® mount breaks away on impact from any angle and automatically resets itself. Plus, all the thrust to take you anywhere



\* Available on select models.

## FEATURES

» Removable Bowguard 360°



» Illuminated Directional Indicator



» Lift-Assist



## CONTROL

Fortrex® Foot Pedal



- Momentary On
- High-Impact Composite Material
- Speed Control
- Side-Mounted Constant On
- Heel-Toe Steering

## SPECS

Thrust Levels	80, 112
Shaft Lengths	45", 52"
Prop	Weedless Wedge 2



# MAXXUM

A tough, reliable workhorse that shows up every day with hard-working features like a Bowguard 360° mount, which breaks away on impact from any direction and automatically resets itself, helping to prevent damage to your boat and motor.

**DIGITAL<sup>+</sup> MAXIMIZER™**  
**5 SPEED\***

**2 YEAR WARRANTY**  
\* Available on select models.

**CONTROL**  
Foot Pedal

**FEATURES**  
Bowguard 360° Mount  
Illuminated Directional Indicator



# EDGE

Compact but powerful, Edge's anodized aluminum mount provides plenty of toughness on smaller boats, plus rock-solid stowing and a Latch & Door design for easy removal.

**5 SPEED**

**2 YEAR WARRANTY**

**CONTROL**  
Foot Pedal  
Tilt / Extend Tiller

**FEATURES**  
Anodized Aluminum Mount  
Directional Indicator



SPECS	Thrust Levels	Shaft Lengths	Prop
Maxxum*	70	42", 52"	Weedless Wedge 2
Edge	45, 55, 70	36", 45", 52"	Weedless Wedge 2 Power Prop
Pontoon Hand Control	55, 70	52"	Weedless Wedge 2

# ULTERRA



SCAN TO LEARN MORE

Push-button stow and deploy let you get in and out of the water more easily than ever, while Power Trim lets you adjust to changing conditions instantly. Push for more with Ultra®.



i-PILOT™



i-PILOT™ LINK\*



AUTOPILOT™



DIGITAL MAXIMIZER™



BUILT-IN™ MEGA



BUILT-IN™ MEGA



US|<sup>2</sup>



SPOT-LOCK



2 YEAR WARRANTY

\* Available on select models.



Control Ultra from your Humminbird fish finder with the One-Boat Network. See more on page 10.



## FEATURES

› Auto Stow/Deploy

› Power Trim



### CONTROL

i-Pilot or i-Pilot Link



Ultra® Foot Pedal



- Momentary On
- Heel/Toe Steering
- AutoPilot On/Off
- Constant On
- Mode
- Speed Control
- Spot-Lock
- Left Steer/Trim Up
- Stow/Deploy/Momentary On
- Right Steer/Trim Down

### SPECS

Thrust Levels	80, 112
Shaft Lengths	45", 60", 72"
Prop	Weedless Wedge 2



# TERROVA

With the right amount of thrust and all the GPS power of i-Pilot or i-Pilot Link, Terrova® unlocks more boat control than ever. That's why it's one of the most trusted, most capable, most proven motors on the water.

- i-PILOT\*
- i-PILOT LINK\*
- AUTOPILOT\*
- DIGITAL MAXIMIZER\*
- BUILT-IN MEGA\*
- SPOT-LOCK\*
- US|\*
- 2 YEAR WARRANTY

\* Available on select models.

### CONTROL

- i-Pilot / i-Pilot Link Remote
- Terrova Foot Pedal

### FEATURES

- Lift-Assist
- Push-To-Test Battery Meter



Control Terrova from your Humminbird fish finder with the One-Boat Network. See more on page 10.



# POWERDRIVE

Get in the game with PowerDrive™, which comes with your choice of i-Pilot or a foot pedal.

- i-PILOT\*
- DIGITAL MAXIMIZER\*
- AUTOPILOT\*
- US|\*
- SPOT-LOCK\*
- 2 YEAR WARRANTY

\* Available on select models.

### CONTROL

- i-Pilot Remote
- PowerDrive Foot Pedal

Note: On PowerDrive, i-Pilot replaces the foot pedal.

### FEATURES

- Deploy-Assist Lever
- Push-To-Test Battery Meter



SPECS	Thrust Levels	Shaft Lengths	Prop
Terrova®	55, 80, 112	45", 54", 60", 72"	Weedless Wedge 2
PowerDrive™	45, 55, 70	48", 54", 60"	Weedless Wedge 2 Power Prop
PowerDrive Pontoon	55, 70	48"	Weedless Wedge 2

# TRAXXIS



Anything your transom-mount can do, Traxxis® can do better. One-Hand Stow, a Quick-Lock Cam Depth Adjuster, and an easy thumb release let you effortlessly get Traxxis in and out of the water or adjust to changing conditions.



DIGITAL  
MAXIMIZER™



2 YEAR  
WARRANTY

## FEATURES

- › Push-To-Test Battery Meter
- › Quick-Lock Cam Depth Adjuster
- › Steering Tension Control
- › One-Hand Stow

## CONTROL

Tilt / Extend Tiller



## SPECS

Thrust Levels	45, 55, 70, 80
Shaft Lengths	36", 42"
Prop	Weedless Wedge 2 Power Prop



# ENDURA

The most trusted motor on the water. Period. Endura™ puts its nose to the grindstone and delivers, day after day, with a nine-position Lever-Lock Bracket that resists flexing, warping and UV damage.

**5** SPEED

**2** YEAR WARRANTY

**CONTROL**

Telescoping Tiller

**FEATURES**

Lever-Lock Bracket



# ENDURA MAX

How do you make the most trusted motor in fishing even more reliable? By giving it more on-the-water run time. Endura Max adds Digital Maximizer for up to five times more time on the water.

**+** DIGITAL MAXIMIZER™

**2** YEAR WARRANTY

**CONTROL**

Telescoping Tiller

**FEATURES**

Push-To-Test  
Battery Meter  
Lever-Lock Bracket



SPECS	Thrust Levels	Shaft Lengths	Prop
Endura™	30, 40, 45, 50, 55	30", 36", 42"	Power Prop
Endura Max	40, 45, 50, 55	36", 42"	Power Prop



# SALTWATER TROLLING MOTORS



# RIPTIDE ULTERRA



SCAN TO  
LEARN MORE



All the thrust you need. Your choice of i-Pilot or i-Pilot Link. And best of all? You can control it with a thumb, thanks to push-button stow, deploy and trim. Meet the most innovative motor in saltwater.



i-PILOT\*



i-PILOT LINK\*



AUTOPILOT™



DIGITAL MAXIMIZER™



SPOT-LOCK



2 YEAR WARRANTY

\* Available on select models.



Control Riptide Ulterra from your Humminbird fish finder with the One-Boat Network. See more on page 10.



## FEATURES

Auto Stow/Deploy

Power Trim

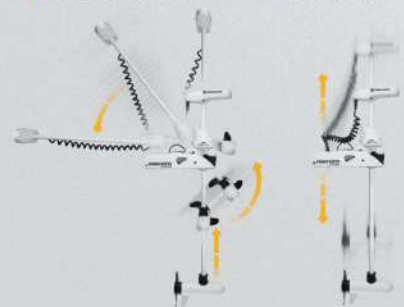

## CONTROL

i-Pilot or i-Pilot Link



Riptide Ulterra Foot Pedal (sold separately)



- Momentary On
- Heel/Toe Steering
- AutoPilot On/Off
- Constant On
- Mode
- Speed Control
- Spot-Lock
- Left Steer/Trim Up
- Stow/Deploy/Momentary On
- Right Steer/Trim Down

## SPECS

Thrust Levels	80, 112
Shaft Lengths	54", 60", 72"
Prop	Weedless Wedge 2

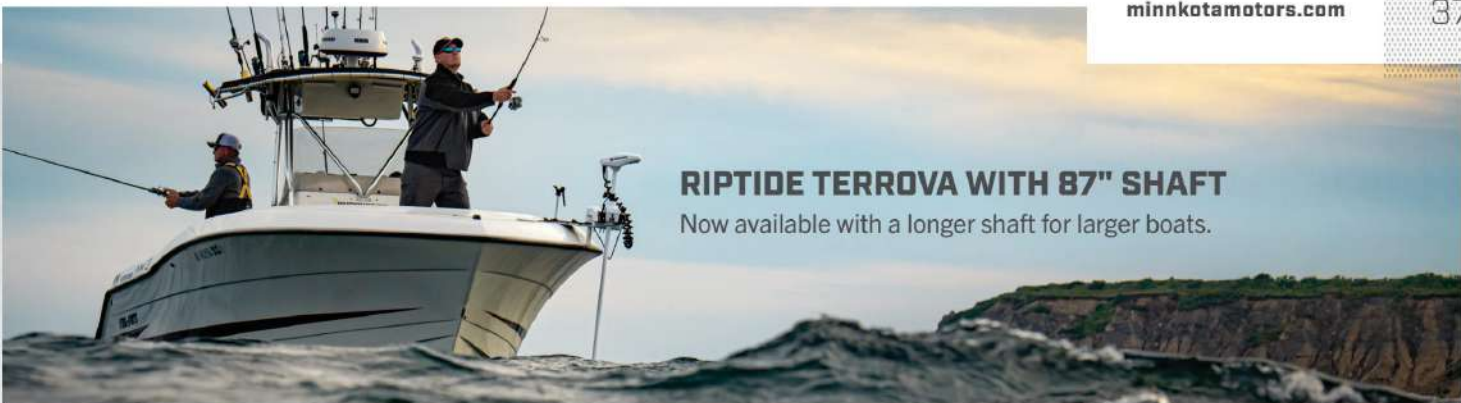

## RIPTIDE TERROVA WITH 87" SHAFT

Now available with a longer shaft for larger boats.



# RIPTIDE TERROVA



Let it rip. Riptide Terrova unleashes as much thrust as any motor in saltwater, while Lift-Assist gets it out of the water effortlessly. Plus, you can upgrade to i-Pilot or i-Pilot Link for revolutionary GPS control.

- i-PILOT\*
- i-PILOT LINK\*
- AUTOPILOT\*
- DIGITAL MAXIMIZER\*
- SPOT-LOCK\*
- 2 YEAR WARRANTY

\* Available on select models.

### CONTROL

- i-Pilot / i-Pilot Link Remote
- CoPilot Remote\*\*
- Riptide Terrova Foot Pedal (sold separately)

### FEATURES

- Lift-Assist
- Push-to-Test
- Battery Meter



Control Riptide Terrova from your Humminbird fish finder with the One-Boat Network. See more on page 10.



# RIPTIDE POWERDRIVE

You miss 100% of the fish you don't chase. But Riptide PowerDrive puts you in the hunt from day one, with reliable performance and smart boat control features.

- i-PILOT\*
- AUTOPILOT\*
- DIGITAL MAXIMIZER\*
- SPOT-LOCK\*
- 2 YEAR WARRANTY

\* Available on select models.

### CONTROL

- i-Pilot Remote
- CoPilot Remote\*\*
- Riptide PowerDrive Foot Pedal (sold separately)

### FEATURES

- Deploy-Assist Lever
- Push-to-Test
- Battery Meter

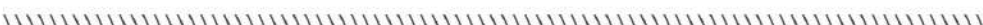

SPECS	Thrust Levels	Shaft Lengths	Prop
Riptide Terrova	55, 80, 112	54", 60", 72", 87"	Weedless Wedge 2
Riptide PowerDrive	55, 70	48", 54"	Weedless Wedge 2

\*\* On CoPilot models, CoPilot remote replaces i-Pilot or i-Pilot Link remote.

# RIPTIDE FORTREX

**CONTROL**  
Tilt / Extend Tiller



**SPECS**

Thrust Levels	80, 112
Shaft Lengths	52", 62"
Prop	Weedless Wedge 2

Stare down saltwater with the trusted power of Riptide Fortrex. It's Mono-Arm Design features an anodized aluminum arm, and its Bowguard 360° mount breaks away on impact and automatically resets itself. Challenge accepted.

**+ DIGITAL MAXIMIZER™**

**2 YEAR WARRANTY**

**FEATURES**

› Lift-Assist



› Removable Bowguard 360°



› Push-To-Test Battery Meter

› Mono-Arm Design

# RIPTIDE MAXXUM

**CONTROL**  
Tilt / Extend Tiller



**SPECS**

Thrust Levels	55, 70, 80
Shaft Lengths	42", 52", 62"
Prop	Weedless Wedge 2

Riptide Maxxum® gives you more power and less to worry about. It packs up to 80 pounds of thrust into a rugged frame, and comes with a Quick-Lock Cam Depth Adjuster and your choice of mount: Latch & Door or Bowguard 360°.

**+ DIGITAL\* MAXIMIZER™**

**5 SPEED\***

**2 YEAR WARRANTY**

\* Available on select models.

**FEATURES**

› Push-To-Test Battery Meter

› Bowguard 360° Mount





# RIPTIDE TRANSOM

Put the power of Riptide on your transom and get up to 112 pounds of thrust and precision maneuverability – plus the battery-boosting power of Digital Maximizer.

**5** SPEED\*

**+** DIGITAL\*  
MAXIMIZER™

**CONTROL**

Tilt / Extend Tiller

**FEATURES**

Lever-Lock Bracket

Push-To-Test Battery Meter

**2** YEAR WARRANTY

\* Available on select models.



SPECS	Voltage	Thrust Levels	Shaft Lengths	Prop
Riptide Transom	–	45, 55, 80, 112	36", 42", 52"	Weedless Wedge 2 Power Prop





# TROLLING MOTOR MODELS

## FRESHWATER BOW-MOUNT



ELECTRIC-STEER CONTROL

MOTOR SPECS

FEATURES

	ULTREX™	ULTERRA®	TERROVA®	POWERDRIVE™
MAX THRUST (LB)	80, 112	80, 112	55, 80, 112	45, 55, 70
SHAFT LENGTHS (IN)	45, 52, 60	45, 60, 72	45, 54, 60, 72	48, 54, 60
MOUNT	Lift-Assist	Auto Stow/Deploy	Lift-Assist	Deploy-Assist Lever
SPEEDS	Variable	Variable	Variable	Variable
CONTROL	Foot Pedal and Remote	Foot Pedal and Remote	Foot Pedal and Remote	Foot Pedal or Remote
WARRANTY	3-Year	2-Year	2-Year	2-Year
BUILT-IN MEGA IMAGING®	Side/Down	Side/Down	Down	—
i-PILOT LINK (GPS)™	●	●	●	—
i-PILOT (GPS)	●	●	●	●
UNIVERSAL SONAR 2	●	●	●	●
AUTOPILOT™	●	●	●	●
COPILOT™	●	●	●	●

## SALTWATER BOW-MOUNT



MOTOR SPECS

FEATURES

	RIPTIDE ULTERRA	RIPTIDE TERROVA	RIPTIDE POWERDRIVE
MAX THRUST (LB)	80, 112	55, 80, 112	55, 70
SHAFT LENGTHS (IN)	54, 60, 72	54, 60, 72, 87	48, 54
MOUNT	Auto Stow/Deploy	Lift-Assist	Deploy-Assist Lever
SPEEDS	Variable	Variable	Variable
CONTROL	Remote	Remote	Remote
WARRANTY	2-Year	2-Year	2-Year
BUILT-IN MEGA IMAGING®	—	—	—
i-PILOT LINK (GPS)™	●	●	—
i-PILOT (GPS)	●	●	●
UNIVERSAL SONAR 2	—	—	—
AUTOPILOT™	●	●	●
COPILOT™	●	●	●

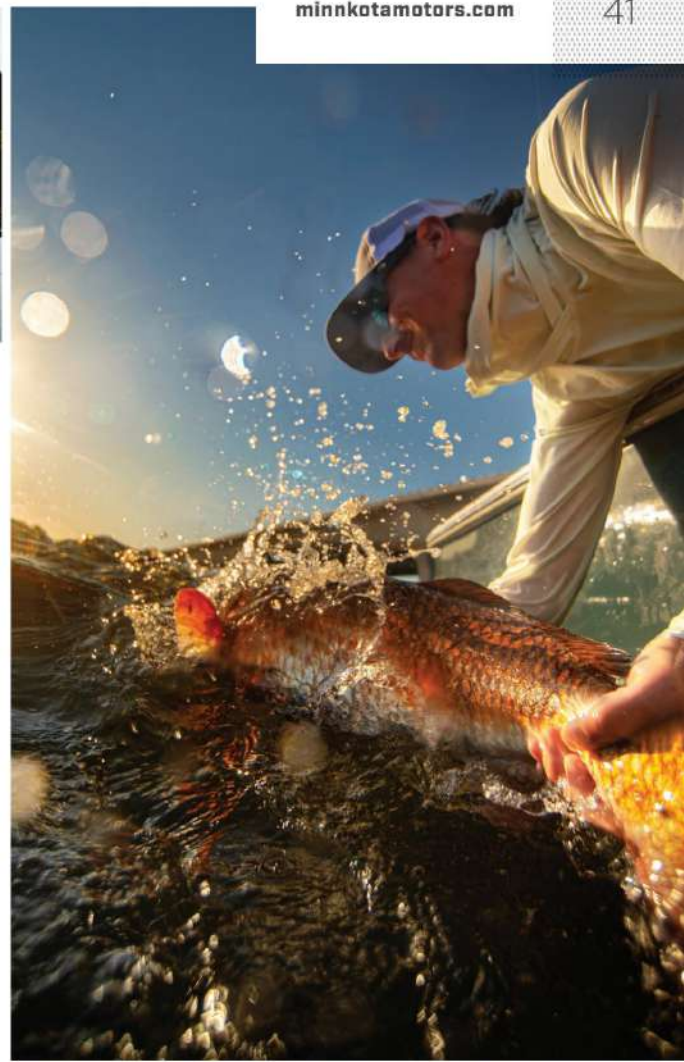

CABLE-STEER CONTROL



**FORTREX®**

80, 112
45, 52
Lift-Assist/Bowguard
Variable
Foot Pedal
2-Year
—
—
—
●
—
—



**MAXXUM®**

70
42, 52
Bowguard
5-Speed or Variable
Foot Pedal
2-Year
—
—
—
—
—
—



**EDGE**

45, 55, 70
36, 45, 52
Latch & Door
5-Speed
Foot Pedal or Tiller
2-Year
—
—
—
—
—
—



**RIPTIDE FORTREX**

80, 112
52, 62
Lift-Assist/Bowguard
Variable
Tiller
2-Year
—
—
—
—
—
—



**RIPTIDE MAXXUM**

55, 70, 80
42, 52, 62
Latch & Door or Bowguard
5-Speed or Variable
Tiller
2-Year
—
—
—
—
—
—

\*CoPilot and AutoPilot available through i-Pilot/i-Pilot Link Systems.  
 \*\*i-Pilot Link integrates with Humminbird fish finders for more features.





# SHALLOW WATER ANCHORS



# RAPTOR

SHALLOW WATER ANCHOR

# TALON

SHALLOW WATER ANCHOR

## WHEN YOU FIND FISH, WE'RE DOWN

From the relentless Raptor to the trusted power of Talon, when you're ready to lock down fish in shallow water, we have your weapon.

### How To Dominate In Shallow Water

A shallow water anchor revolutionizes the way you stay on fish. Both Raptor and Talon give fish nowhere to run and nowhere to hide. Zero in on your target by keeping your boat in the exact position and orientation you want, with a whisper-quiet anchor and no prop to disturb sediment or spook fish.

### Anchor in Anything

Raptor and Talon can adjust their anchoring force based on what kind of bottom you're anchoring into, so you get the right amount of power you need for a secure hold in rocks, silt, mud or sand. Raptor can even sense the bottom automatically, dialing in the right amount of force for the job.

### Control From Anywhere

Raise and lower your anchor from the unit, a dedicated remote control, an i-Pilot remote, or a mobile app. And because both Raptor and Talon are on the One-Boat Network, you can even control them from your Humminbird fish finder.



# RAPTOR IS RELENTLESS

It never stops attacking. Never stops working to keep you locked in. It never stops stopping. This is Raptor. Only from Minn Kota.

## KNOW WHEN TO FIGHT BACK

You don't know what it's like down there. But Raptor does. It's built to sense anything that threatens to knock you off your spot, then counterpunch to keep you locked in no matter what.



### ACTIVE ANCHORING

#### › Active Anchoring

Only Raptor can automatically anchor you back in when wind and waves pick up. Its patented Active Anchoring feature senses if you start to lose your hold, then anchors you back in. You stay fishing, and Raptor stays ready for the next wave.



### AUTO-BOTTOM MODE

#### › Auto-Bottom Mode\*

Whether you're anchoring into rocks, mud, silt, sand or anything else – Raptor can sense what it is and automatically apply the right hold. So you get enough power to anchor in without getting stuck in the mud.

#### › User-Selectable Anchoring Modes

Auto-Bottom Mode is just one of four anchoring modes that help you get the right hold in any condition. You can also choose from:

##### STANDARD MODE

for most situations

##### ROUGH WATER MODE

for rough wind and heavy chop

##### SOFT BOTTOM MODE

for anchoring into soft mud and silt

#### › Unrivaled Retraction Force

When you're ready to move spots, so is Raptor. We packed it with unparalleled retraction force to quickly get you out of the bottom and onto your next spot.

\* Select Models Only



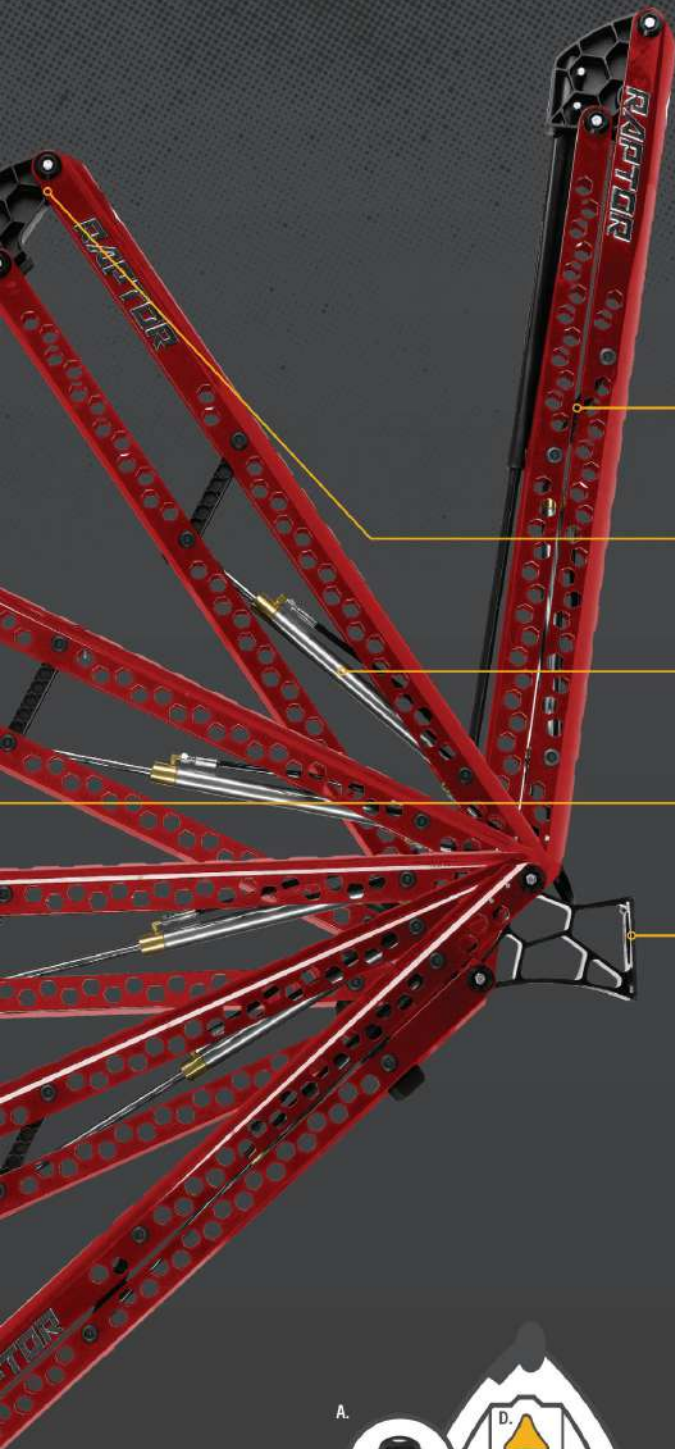

## POWER TO RELY ON

Raptor stands your ground, and stands the test of time. It's built with Minn Kota toughness and backed up with a comprehensive 5-year warranty.



# WARRANTY



SCAN TO LEARN MORE

CORROSION-RESISTANT ALUMINUM CONSTRUCTION

REINFORCED PIVOT POINTS TO REDUCE WEAR

HYDRAULIC-POWERED DESIGN

COMPOSITE ANCHORING SPIKE: GUARANTEED FOR LIFE

SINGLE-PIECE EXTRUDED ALUMINUM MOUNTING BRACKET

### » Built for Saltwater

Nothing stops Raptor – it's even engineered to fully combat saltwater corrosion.

### » The Best Shallow Water Anchor Warranty

Raptor comes with a five-year warranty on all components and electronics – plus a lifetime warranty on the spike.

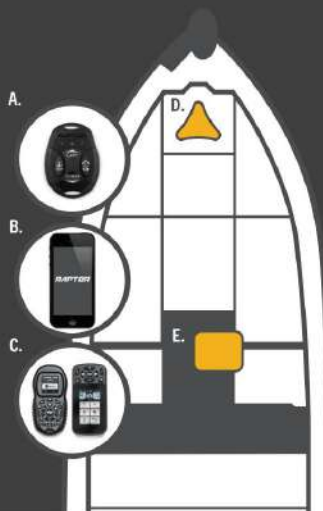

## ALWAYS IN COMMAND

Control Raptor easily, with one-touch Auto Up/Down. And anchor in from anywhere on the boat, with these control options:

- A. Raptor Remote
- B. Raptor Mobile App
- C. i-Pilot or i-Pilot Link Remote
- D. Wireless Foot Switch / Stomp Switch
- E. Humminbird Fish Finder



# TALON DOWN. GAME ON.

When you find the right fishing spot, time is critical. You can't wait to anchor, can't wait to cast, and can't be bothered to move until you get what you came for. That's why we designed every inch of Talon to hold you in place effortlessly and relentlessly – every time out.



SCAN TO  
LEARN MORE



Control Talon from your Humminbird fish finder or i-Pilot Link remote with the One-Boat Network. See more on page 10.

## FAST, EASY ANCHORING – FROM ANYWHERE

### Control Talon from Anywhere

- A. Talon Control Panel
- B. Talon Remote
- C. Talon Mobile App
- D. i-Pilot or i-Pilot Link Remote
- E. Wireless Foot and Stomp Switches
- F. Humminbird Fish Finder

### Lock in at the Push of a Button

Auto Up/Down gives you one-touch stow and deploy that's as easy as using a car's automatic windows.

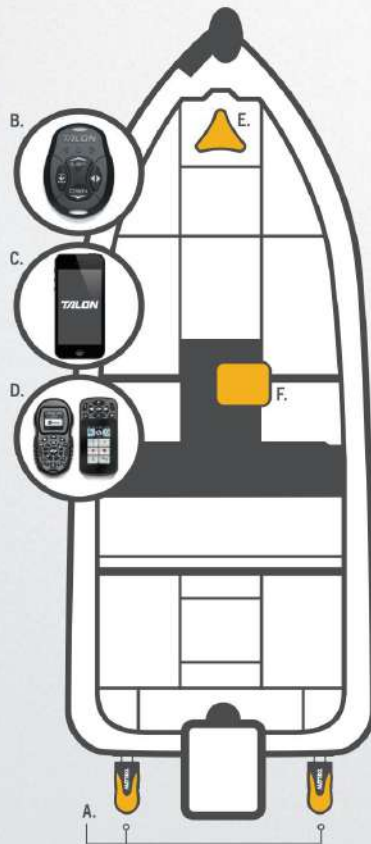

## THE STRONGEST HOLD ON THE WATER

### Twice the Force

Talon deploys with twice the anchoring force of the competition, so you can hold in any spot.

### Anchor in Anything

Talon's exclusive User-Selectable Anchoring Modes give you the perfect hold in any condition.



**Standard Mode**  
For most anchoring situations.

**Rough Water Mode**  
For heavy wind and chop.

**Soft Bottom Mode**  
For muddy or silted bottoms.

### Put Heavy Chop in its Place

Talon's built-in floating suspension keeps your boat locked to the bottom even in rough water, enabling your boat to move up or down without affecting the anchor.

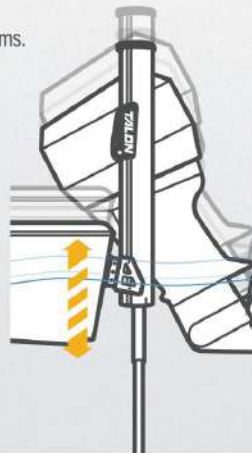



## FULLY LOADED, RIGHT OUT OF THE BOX

### › Built-In Work Light

Tie lines and work from the transom until sundown. Features blue and white lights with three brightness settings.



### › LED Depth Indicator

Get a quick read on exactly how far down Talon is deployed. Features three brightness settings.



### › Pivoting Design

Talon can slide up and down, pivot up to 30°, and be easily removed for storage.

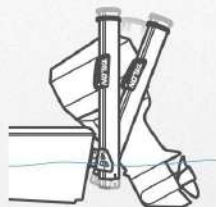

### › Talon Remote

Talon comes standard with a wireless remote that controls stow, deploy, anchoring mode and the work light.



### › Indestructible Anchoring Spike

Withstands years of abuse, no matter what you put it through. **GUARANTEED FOR LIFE.**



### › Deployment Notification Alarm

Alerts you if you try to take off while Talon is deployed.

### › Saltwater Tough

Like all of our saltwater products, Talon is built to combat the corrosive effects of saltwater.

### › Five-Year Warranty

A rock-solid warranty on Talon and its accessory brackets, plus a lifetime warranty on the spike.



# TALON VS. RAPTOR

Choose your weapon, then choose your spot.

## TALON

## RAPTOR





	<b>TALON</b> • SHALLOW WATER ANCHOR •	<b>RAPTOR</b> • SHALLOW WATER ANCHOR •
<b>ACTIVE ANCHORING</b>	—	AVAILABLE
<b>USER-SELECTABLE ANCHORING MODES</b>	X	X
AUTO-BOTTOM MODE		X*
<b>DEPLOYMENT</b>	VERTICAL	ARTICULATING
<b>MOUNTING AND INSTALLATION</b>		
BRACKET STYLE	3-PIECE EXTRUDED ALUMINUM	SINGLE-PIECE EXTRUDED ALUMINUM
DESIGN	ELECTRO-MECHANICAL	HYDRAULIC
<b>CONTROL</b>		
ON UNIT	X	X
REMOTE	X	X
i-PILOT / i-PILOT LINK	X	X
HUMMINBIRD (ONE-BOAT NETWORK)	X	X
MOBILE APP	X	X
<b>INCREASED DEPLOYMENT FORCE</b>	X	X
<b>INCREASED RETRACTION FORCE</b>	X	X
<b>ANCHORING SPEED</b>	PRE-SET	ADJUSTABLE
<b>AUTO UP / DOWN</b>	X	X
<b>BUILT-IN FLOATING SUSPENSION</b>	X	—
<b>BUILT-IN WORK LIGHT</b>	X	—
<b>LED DEPTH INDICATOR</b>	X	—
<b>PIVOTING DESIGN</b>	X	—
<b>WIRELESS REMOTE</b>	X	X
<b>DEPLOYMENT NOTIFICATION ALARM</b>	X	—
<b>INDESTRUCTIBLE ANCHORING SPIKE</b>	X	X
<b>ENGINEERED FOR SALTWATER</b>	X	X
<b>WARRANTY</b>	<ul style="list-style-type: none"> <li>• 5-YEAR COMPREHENSIVE</li> <li>• LIFETIME ON SPIKE</li> </ul>	<ul style="list-style-type: none"> <li>• 5-YEAR COMPREHENSIVE</li> <li>• LIFETIME ON SPIKE</li> </ul>

\*On Active Anchoring models

# MOUNTING AND ACCESSORIES

## RAPTOR MOUNTING BRACKETS

Raptor's single-piece aluminum brackets provide superior strength and a rock-solid hold on the back of your boat. They're powder-coated for corrosion resistance in any situation, and mounted with stainless steel hardware. Just choose how you want to mount Raptor and we've got the perfect bracket for you.



Setback Bracket

Angle Bracket

Jack Plate Bracket

Universal Sandwich Bracket Adapter

## RAPTOR MOUNTING ACCESSORIES

ITEM #	DESCRIPTION	PORT/STARBOARD	SETBACK	RISE
1810370 (BLACK) 1810375 (WHITE)	Raptor 3" Setback Bracket	Both	3"	NA
1810371 (BLACK) 1810376 (WHITE)	Raptor Direct Mount Angle Bracket	Both	5"	NA
1810360 (BLACK) 1810365 (WHITE)	Raptor Jack Plate Adapter Bracket – S24	Starboard	2"	4"
1810361 (BLACK) 1810366 (WHITE)	Raptor Jack Plate Adapter Bracket – P24	Port	2"	4"
1810362 (BLACK) 1810367 (WHITE)	Raptor Jack Plate Adapter Bracket – S26	Starboard	2"	6"
1810363 (BLACK) 1810368 (WHITE)	Raptor Jack Plate Adapter Bracket – P26	Port	2"	6"
1810380 (BLACK) 1810382 (WHITE)	Raptor Jack Plate Adapter Bracket – S54	Starboard	5"	4"
1810381 (BLACK) 1810383 (WHITE)	Raptor Jack Plate Adapter Bracket – P54	Port	5"	4"
1810384 (BLACK) 1810386 (WHITE)	Raptor Jack Plate Adapter Bracket – S86	Starboard	8"	6"
1810385 (BLACK) 1810387 (WHITE)	Raptor Jack Plate Adapter Bracket – P86	Port	8"	6"
1810388 (BLACK) 1810389 (WHITE)	Raptor Universal Sandwich Adaptor – allows installation of jack plate brackets without a jack plate	Both	NA	NA
1810356 (BLACK) 1810357 (WHITE)	Universal Jack Plate Spacer – provides additional clearance for outboard engine	Both	NA	NA

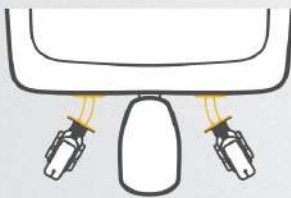

### Direct to Transom Mounting

#### Direct Mount Angle Bracket

If you're mounting directly to your transom, this bracket delivers maximum holding power and an optimal deployment angle for Raptor.

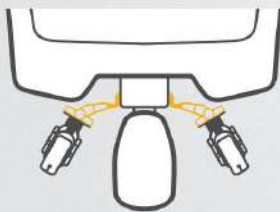

### Jack Plate Mounting

#### Jack Plate Brackets

Mount Raptor to your outboard's jack plate on either the port or starboard side. First choose how much rise you need (4" for smaller boats, or 6" for larger, heavier ones). Then decide how much setback (2", 5" or 8") you need between Raptor and the transom to account for rigging. You can also use these brackets without a jack plate by adding the Raptor Universal Sandwich Adaptor.

## ACCESSORIES For a complete listing of accessories, visit [minnkotamotors.com](http://minnkotamotors.com).



### Foot Switch

Control your anchor from the bow, with full command of stow, deploy, anchoring modes and Talon's work light.



### Stomp Switch

Raise or lower either Talon or Raptor, quickly and easily.



### Protective Covers

Available for all sizes of Talon and Raptor, these durable, UV-resistant covers feature an all-weather, corrosion-resistant zipper.



### ADDED SECURITY

All mounting and adapter brackets for Raptor and Talon carry a five-year warranty.

### TALON MOUNTING BRACKETS

Get a secure, versatile hold with Talon brackets. Built tough, with reinforced construction, they can be adjusted on two pivot points to the perfect orientation for your transom. Here's how to pick the right one.



**Flat Transom**  
No adapter bracket needed. All hardware is included for direct-to-transom installation.

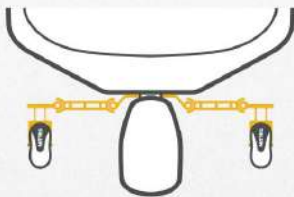

**Curved Transom**  
**Sandwich-Style Adapter Bracket**  
Mounts Talon between the jack plate and transom OR between the outboard and transom. Choose from port or starboard versions.

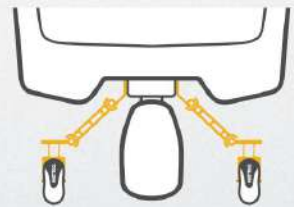

**Curved Transom with Outboard Jack Plate**  
**Side-Mounted Jack Plate Adapter Bracket**  
Mounts Talon directly to the side of your jack plate. Design is interchangeable for port or starboard mounting.



### TALON MOUNTING ACCESSORIES

ITEM #	DESCRIPTION	SETBACK	PORT/STARBOARD
1810340	Talon Side-Mounted Jack Plate*	Variable	Both
1810302	Talon Sandwich-Style	Variable	Port
1810303	Talon Sandwich-Style	Variable	Starboard
1810212	Talon Bob's Machine Shop Side Shim Kit – fills recess gap on side of Bob's Machine Shop jack plate; for jack plate mounting.**	NA	Both
1810220	Setback Bracket, 6" – for direct mount installations only	6"	Both
1810225	Talon Pontoon Edge Mounting Bracket Kit	NA	Both
1810226	Talon Pontoon Performance Kit	NA	Both

\*Minn Kota Talon Side-Mounted Jack Plate Adapter Brackets include hardware for Atlas hydraulic, Z-Lock manual and Slidemaster manual jack plates. Not all jack plates are equipped with mounting holes to accept side-mount adapter brackets. Drilling holes to accept side-mount adapter brackets may void your manufacturer's warranty. Minn Kota is not responsible for damage that may result.  
\*\*For Bob's Machine Shop models manufactured before 2009.



**Pontoon Mounting Bracket**  
Easily and securely mount Talon to your pontoon with this rugged bracket.



**Talon Tilt Bracket**  
This marine-grade, anodized aluminum tilt bracket accommodates for low clearance areas and boat storage. Features adjustable deck support for added stability while tilting.



**Quick Release Disconnect Plug**  
This heavy-duty, waterproof connector features an all-inclusive screw-lock design.

A man wearing a grey hoodie and a cap is kneeling on a boat, working on a battery charger. The charger is connected to various cables and components. The background shows the boat's interior and a window.

# BATTERY CHARGERS

We know what it takes to power the best trolling motors and shallow water anchors on the water. That's why we built the toughest, smartest chargers on the water that make sure your batteries are ready for the next run – and that they stay ready for years to come.

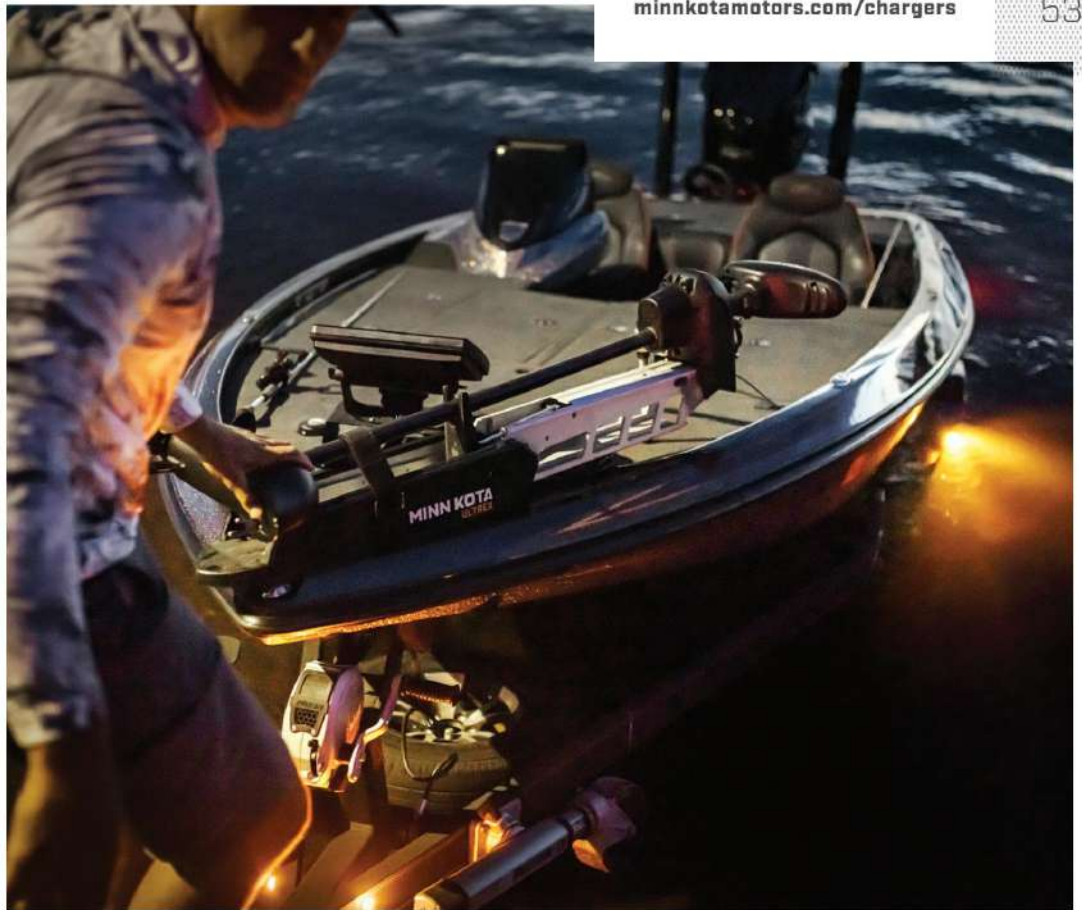

# FOR THE LONG HAUL



## ON-BOARD MARINE BATTERY CHARGERS

Plug in. Turn in for the night. Then get up the next day and do it all over again. But what happens in the hours when your battery is hooked up to a charger? If that charger has our name on it, a lot. We build them tough and reliable, of course. But we've also packed them with a variety of technologies that keep your batteries protected and running like new for years.

Here's your wake-up call: it's time for a charger that keeps you on the water longer.



**DIGITAL  
CONTROL**

## THE POWER OF DIGITAL

When you over- or under-charge your battery, you shorten its overall life. Minn Kota chargers are digitally designed to deliver just the right amount of power every time you plug in. No more. No less. Just a longer-lasting, better-performing battery.

### Automatic Temperature Compensation

Minn Kota chargers adjust for fluctuations in temperature to prevent damaging your battery.

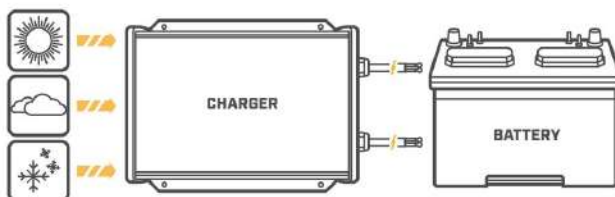

### Automatic Multi-Stage Charging

By controlling the voltage and current your battery receives at each stage of the charging cycle, you get a fast, safe charge.

### AC Plug Holder

Keeps plug dry, safe and easily accessible.



### LED Status Display

Get a quick read on charging progress and more with the LED displays on each of our chargers.

#### PRECISION ON-BOARD CHARGERS



#### DIGITAL ON-BOARD CHARGERS



#### PORTABLE CHARGERS



### Rugged and Waterproof

Our on-board chargers are shock-resistant, vibration-resistant, waterproof and saltwater-tested to fully combat corrosion.

## ON-BOARD ALTERNATOR BATTERY CHARGERS

In addition to our standard chargers, we have Alternator chargers that take your alternator's excess power and redistribute it to your trolling batteries, giving them an extra boost and better battery life.

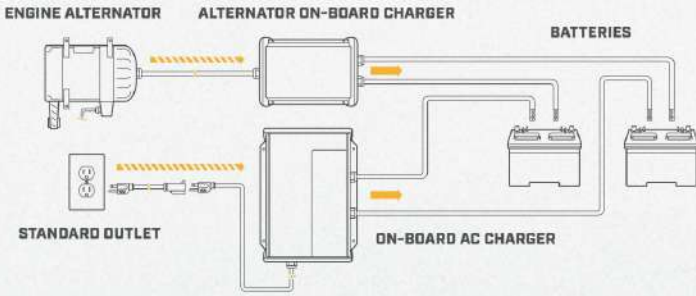

NOTE: Alternator On-Board Battery Charger supplements – does not replace – your standard on-board AC battery charger. (2-bank system shown)

## PRODUCT SPECIFICATIONS

(For use in conjunction with On-Board AC Chargers)



SPECIFICATIONS	MK 10C	MK 20C	MK 30C
ITEM #	1821031	1821032	1821033
# OF BANKS	1	2	3
OUTPUT PER BANK* [AMPS]	10	10	10
TOTAL OUTPUT* [AMPS]	10	20	30
LENGTH	7"	10-1/2"	14-1/2"
WIDTH	7-1/4"	7-1/4"	7-1/4"
HEIGHT	3-1/2"	3-1/2"	3-1/2"
WEIGHT [POUNDS]	5.0	6.5	8.5

\* Dependent on alternator output.



**PRECISION  
CHARGERS**

## THE PRECISION DIFFERENCE

Next-level battery protection and performance is yours with our Precision on-board chargers. And now, they're built to get even more out of lithium batteries.

### Low-Line Voltage Compensation

When outlets get overloaded or hooked up to long extension cords, they don't put out the 120 volts they're supposed to. Precision chargers compensate to deliver a fast, consistent charge – no matter what.

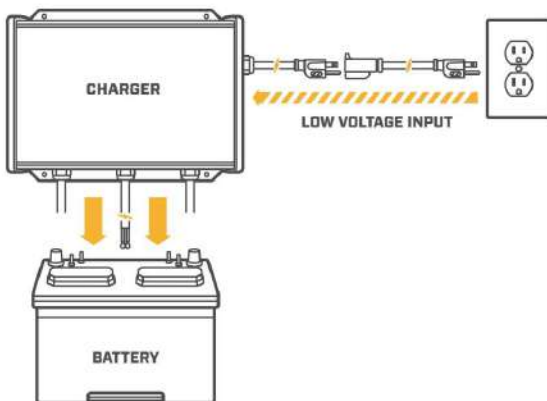

### Built For Lithium

We've redesigned our Precision line to get even more out of your lithium batteries. These advanced chargers can now wake lithium batteries up from standby mode, feature up to five banks, and eliminate damaging under- or over-charging. So you get the most out of your batteries, and more time on the water.

### Battery Equalization\*

Equalization cleans and protects your battery – and Precision chargers do it automatically, every time you plug in. You can also manually activate a more rigorous cleaning at the push of a button.

\*For Flooded Lead Acid Batteries Only

### Custom Charging

On each bank of our Precision chargers, you can select which battery type (AGM, flood lead acid or lithium) you've got plugged in, to dial in a charge that's optimized for that battery.

# BATTERY CHARGER BUYING GUIDE

Finding the Right Charger is as Easy as 1-2-3

## 1

### HOW MANY BANKS DO YOU NEED?

That depends on how many batteries you need to charge — you need one bank for each battery (include your starting battery, if applicable).



1 battery = 1 charging bank

## 2

### HOW MUCH POWER DO YOU NEED?

More powerful charging banks mean faster recharging and faster recovery time.



3 to 5 hours  
recovery time  
= 15 amps per bank



4 to 6 hours  
recovery time  
= 10 amps per bank



10 to 12 hours  
recovery time  
= 5 or 6 amps per bank

## 3

### SELECT YOUR CHARGER

Use this chart to pick the features and technologies you want, then choose the model you want. Learn more about our charger technologies on pages 54-55.

### PRECISION ON-BOARD MARINE BATTERY CHARGERS



SPECIFICATIONS	MK 108PCL	MK 110PCL	MK 212PCL	MK 220PCL	MK 230PCL	MK 318PCL
ITEM #	1831061	1831101	1832121	1832201	1832302	1833181
# OF BANKS	1	1	2	2	2	3
OUTPUT PER BANK [AMPS]	6	10	6	10	15	6
TOTAL OUTPUT [AMPS]	6	10	12	20	30	18
CHARGE TIME <sup>1</sup> [HOURS]	10 to 12	4 to 6	10 to 12	4 to 6	3 to 5	10 to 12
LENGTH	9-3/4"	9-3/4"	9-3/4"	9-3/4"	9-1/2"	9-3/4"
WIDTH	4"	4"	5-3/4"	5-3/4"	7-3/4"	7-3/4"
HEIGHT	3-1/2"	3-1/2"	3-1/2"	3-1/2"	3"	3-1/2"
WEIGHT [POUNDS]	4.4	4.4	6.2	6.2	10.0	8.1
AUTOMATIC TEMPERATURE COMPENSATION	X	X	X	X	X	X
AUTOMATIC MULTI-STAGE CHARGING	X	X	X	X	X	X
DIGITAL CONTROL	X	X	X	X	X	X
THREE-YEAR REPLACEMENT WARRANTY	X	X	X	X	X	X
LED STATUS DISPLAY	X	X	X	X	X	X
BATTERY EQUALIZATION <sup>2</sup>	X	X	X	X	X	X
LOW-LINE VOLTAGE COMPENSATION	X	X	X	X	X	X
BATTERY TYPE SELECTION BY BANK	X	X	X	X	X	X
WATERPROOF, SHOCK- AND VIBRATION-RESISTANT ALUMINUM CONSTRUCTION	X	X	X	X	X	X
SALTWATER TESTED Fully corrosion-resistant construction	X	X	X	X	X	X
FOR USE WITH 12-, 24-, 36- or 48-volt systems with 12V/6 cell batteries that are Flooded/Wet Cell, Maintenance Free, Starved Electrolyte (AGM/HP AGM) or Lithium <sup>3</sup> only	X	X	X	X	X	X
FOR USE WITH 12V/6 cell batteries (50-130 amp hour rating) that are Flooded/Wet Cell, Maintenance Free, Starved Electrolyte (AGM) or Lithium <sup>3</sup> only	—	—	—	—	—	—
12V LITHIUM ION [LiFePO4] OPTIMIZED <sup>4</sup>	X	X	X	X	X	X
FCC COMPLIANT	X	X	X	X	X	X
CEC COMPLIANT Certified Battery Charging System per the California Energy Commission	X	X	X	X	X	X

<sup>1</sup> Approximate time to restore deep cycle batteries at 60% discharge. <sup>2</sup> For Flooded Lead Acid Batteries Only. <sup>3</sup> Not For Sale in California.

<sup>4</sup> Check battery manufacturer's specifications. <sup>5</sup> While lithium-based batteries can be used with all Minn Kota Precision and Digital chargers, PCL chargers have been designed with charge curves specifically for Lithium Ion (LiFePO4) batteries and are able to wake these battery types from standby.



# RIGGING AND ACCESSORY GUIDE

Make sure your new Minn Kota is ready to fish on day one – and optimized with accessories and add-ons that let you get more out of the most trusted motor on the water.



## QUICK RELEASE BRACKETS FOR EASY MOTOR REMOVAL

A Quick Release Bracket lets you easily remove your motor from your bow for safe storage any time. Factory made for a perfect fit and built tough for years of use.

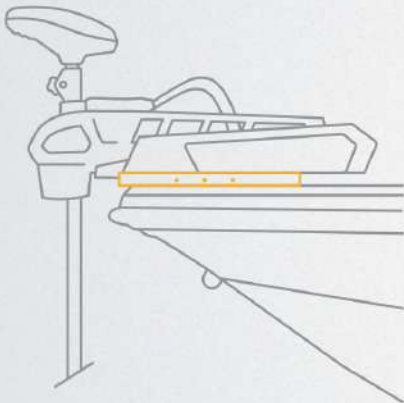

## GET EVERYTHING YOU NEED TO FISH WITH i-PILOT OR i-PILOT LINK

i-Pilot and i-Pilot Link take your motor to the next level – and these accessories make them even easier to use.

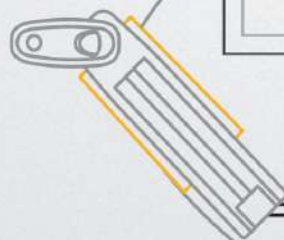

## PROTECT YOUR MOTOR WITH A STABILIZER KIT

Heavy chop and wake can bounce your motor up and down. Stabilize and protect it with one of these kits. It pivots into a vertical position when the motor is stowed, locking it into place.

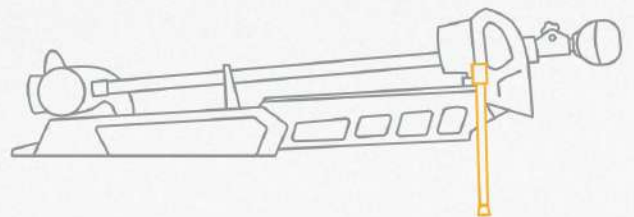

## TROLLING MOTOR PLUG AND RECEPTACLE FOR QUICK CONNECTION

Adjustable mounting locations and provides continuous power rated to 60 amps up to 48V.



Pos +

Neg -

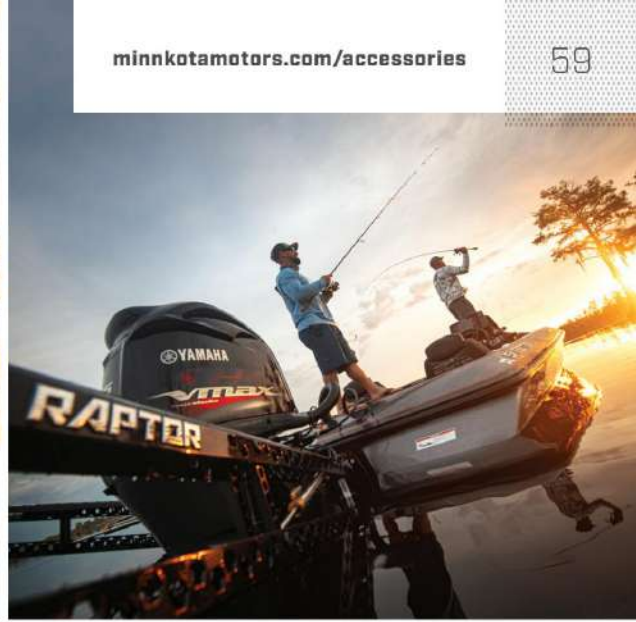
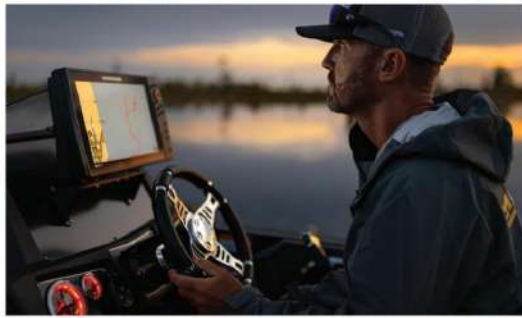

### CHOOSE AN ADAPTER CABLE TO CONNECT YOUR MOTOR TO YOUR FISH FINDER

Motors with integrated sonar transducers deliver crystal clear images to your fish finder, while protecting the transducer and eliminating the clutter and hassle of exposed wires. These adapter cables connect your motor to your fish finder. Which ones you need depends on what kind of sonar transducer is built into your motor.



### PICK UP THE POWER YOU NEED

The diagram on this page shows how to wire a 36V system – but however you’re rigged up, we have the hardest working smart chargers and accessories on the water to keep you powered up.

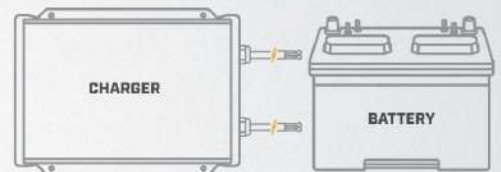

### PROTECT YOUR WIRING WITH A CIRCUIT BREAKER

Protects your trolling motor from electrical damage.

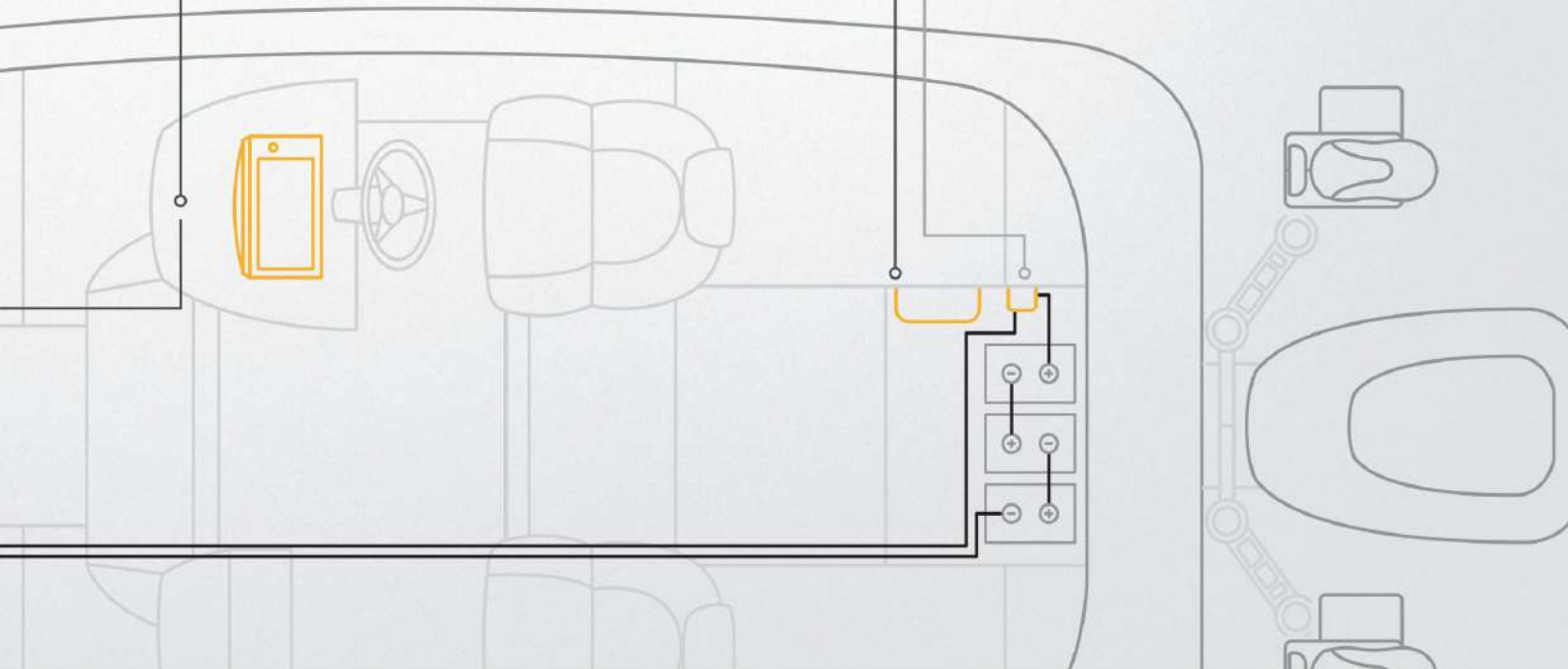

## QUICK RELEASE BRACKETS



MKA-53



RTA-54



Trolling motor attaches to top of bracket. Bracket locks in over top of deck-mounted center puck.



MKA-32

Cover included with quick release bracket.



MKA-16-03

MKA-42

### Composite Quick Release Brackets

Super tough and super secure. Made with high-yield composite material, these brackets are impervious to corrosion and feature a low-profile design that leaves the deck clear when the motor is removed. Plus, a locking handle with stainless steel pins can be secured with padlock (not included, sold separately).

### Aluminum Quick Release Brackets

A cam-lock design and ultra-tight tolerances eliminate bracket movement and noise. The locking lever includes a pin and lanyard. The upper and lower plates can be secured with a padlock (not included) or side screw.

TROLLING MOTOR	COMPOSITE						ALUMINUM				
	MKA-21	MKA-23 <sup>**</sup>	RTA-17	RTA-19	MKA-53 <sup>*</sup>	RTA-54 <sup>*</sup>	MKA-32 <sup>**</sup>	MKA-51 <sup>***</sup>	MKA-16-03	MKA-42 <sup>†</sup>	MKA-52/62 <sup>†</sup>
ULTERRA	X				X		X	X	X		
TERROVA	X				X		X	X	X		
POWERDRIVE V2	X						X	X	X		
POWERDRIVE	X						X	X	X		
POWERDRIVE PONTOON	X						X	X	X		
ULTREX		X								X	X
FORTREX		X								X	X
MAXXUM		X								X	X
EDGE		X								X	
RIPTIDE ULTERRA						X					
RIPTIDE TERROVA			X			X					
RIPTIDE POWERDRIVE V2			X								
RIPTIDE FORTREX				X							
RIPTIDE MAXXUM				X							
RIPTIDE EDGE				X							

\* For higher-thrust motors with 72" shafts, opt for the MKA-53 or RTA-54 bracket.

\*\* MKA-32 includes a composite cover to keep the deck clean when the motor is removed.

\*\*\* MKA-51 can slide back 6" for easy storage and security.

† MKA-42 fits 45" and shorter foot control motors, and 52" and shorter hand control models.

MKA-52/62 fits 52"-72" shaft foot control motors, and 62" shaft hand control motors.

\*\* Not designed for motors larger than 80 pounds of thrust and 60" shafts.

## MEGA LIVE + MEGA 360 ULTREX BRACKET

NEW

### MEGA Live Imaging® TargetLock™ and MEGA 360 Imaging® Ultrex Mount



This accessory mount is used to increase the lift-assist force of Ultrex when mounted with both Humminbird MEGA Live Imaging TargetLock and MEGA 360 Imaging®. Available for all Ultrex shaft lengths and thrust levels, it serves as a direct replacement for the existing Ultrex bracket.

**1854080** (80 lb, 45")

**1854081** (80-112 lb, 52"-60")

**1854082** (112 lb, 45")

## BOW-MOUNT STABILIZER KITS



MKA-50



MKA-55

TROLLING MOTOR	MKA-50	MKA-55
ULTERRA		X
TERROVA		X
POWERDRIVE V2		X
POWERDRIVE		X
POWERDRIVE PONTOON		X
FORTREX	X	
RIPTIDE FORTREX	X	

## FISH FINDER ADAPTER CABLES



### Built-In MEGA Imaging Adapters

Shielded cables deliver crystal clear MEGA Imaging, connecting your Humminbird HELIX® fish finder to a Minn Kota motor with Built-In MEGA Imaging. Adapter not required for Humminbird SOLIX® models.



**MKR-MI-1** HELIX 8, 9, 10, 12      **MKR-MDI-2** HELIX 7



### Universal Sonar 2 Adapters

Universal Sonar 2 delivers streamlined, interference-free sonar performance and DualBeam PLUS™ technology for the best view of the waters below. These adapters connect your motor to your favorite brand of sonar or fish finder\* with waterproof connectors.

<b>MKR-US2-1</b>	Garmin**	<b>MKR-US2-12</b>	Garmin Echo*
<b>MKR-US2-8</b>	Humminbird 7-pin*	<b>MKR-US2-13</b>	Humminbird ONIX**
<b>MKR-US2-9</b>	Lowrance® 6-pin*	<b>MKR-US2-14</b>	Garmin 8-pin*
<b>MKR-US2-10</b>	Lowrance/Eagle Blue*	<b>MKR-US2-15</b>	Lowrance 8-Pin TripleShot (Hook2)
<b>MKR-US2-11</b>	Universal Sonar 2 Extension Cable	<b>MKR-US2-16</b>	Lowrance 9-Pin Total Scan (Elite Ti2 and HDS)



For a complete compatibility list, visit [minnkotamotors.com](http://minnkotamotors.com).

\* 200kHz/83kHz DualBeam compatible and only provides traditional 2D sonar.

## i-PILOT AND i-PILOT LINK ACCESSORIES



### Micro Remote for i-Pilot and i-Pilot Link\*

Get compact, simple control of i-Pilot or i-Pilot Link. This Bluetooth® Micro Remote accessory delivers quick command of Spot-Lock, speed, steering and Advanced AutoPilot.



### i-Pilot Link Charging Cable

Five-foot charging cable features a USB terminal that lets you choose between AC and DC power (AC and DC adapters not included).



### Replacement Remotes\*

Get a spare or replacement Bluetooth-enabled remote for your i-Pilot or i-Pilot Link system. Both remotes are waterproof and feature a large display for instant feedback.

\* See [minnkotamotors.com](http://minnkotamotors.com) for additional legacy product accessories.

### For PowerDrive or Riptide PowerDrive with i-Pilot, Consider a Heading Sensor

This heading sensor enables the Jog feature on motors with Spot-Lock, allowing you to move your Spot-Lock five feet in any direction. Most i-Pilot-equipped motors come with a heading sensor, but it's sold separately on PowerDrive and Riptide PowerDrive.



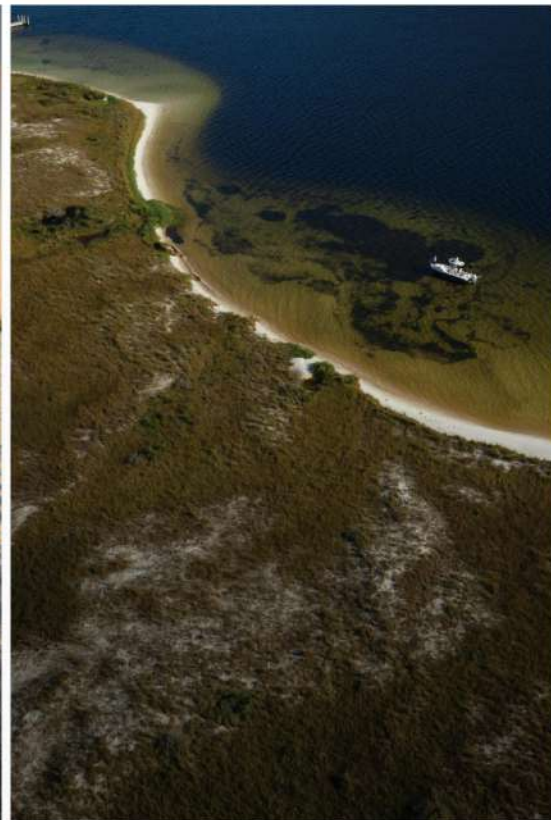
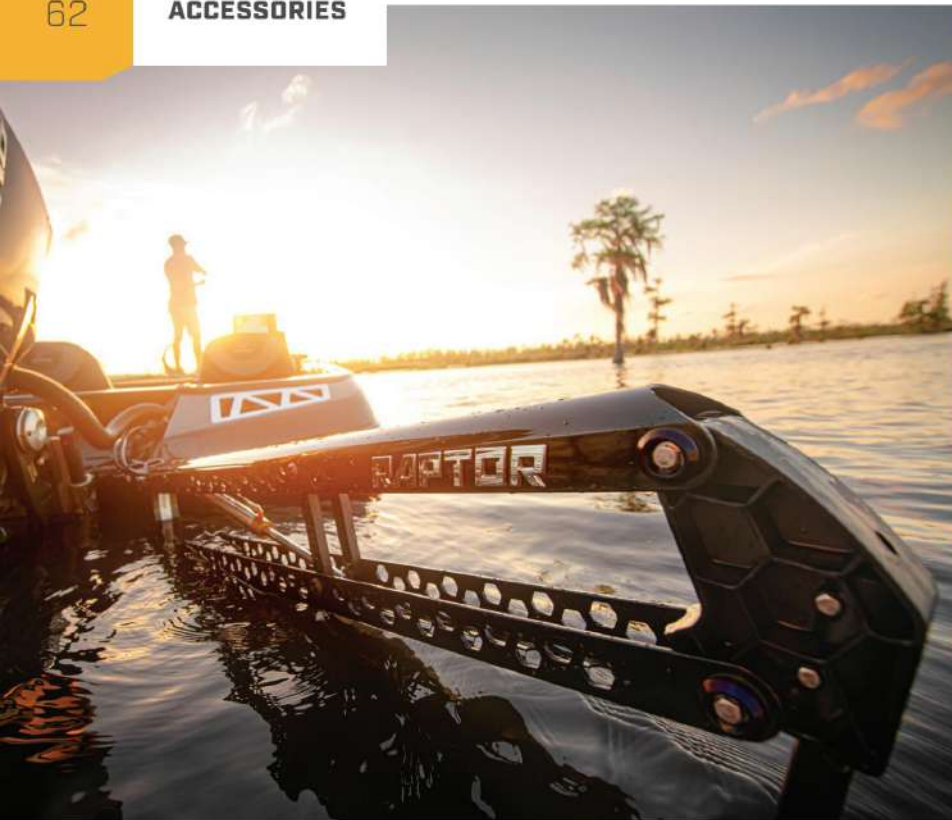

## BATTERY ACCESSORIES



### › Battery Power Center

For small boat, transom applications, these easy access external battery terminals allow trolling motor leads and charger leads to be connected without opening the box. Built-in battery meter includes two 12-volt accessory plugs, and two manual reset circuit breakers (10 amp for accessory plugs and 60 amp for trolling motor). Fits group 24- and 27-size batteries.



### › Digital Battery Meter

Monitor the voltage level and "state of charge" of any 12-volt battery with a LCD display mounted on a compact frame that's easy to store anywhere. Includes LEDs that indicate full, 2/3, 1/3 or 0 "state of charge."

**MK-BM-10**



### › Trolling Motor Quick Connect Plug

Heavy-duty connector has positive snap-lock design for 6- to 12-gauge wire. Kit includes two plug halves, four contacts and four solder plugs for securing wire leads into the contacts (wire not included).

**MKR-20**



**NEW**

### › Motor Plug and Receptacle

Get a corrosion-resistant, watertight connection, featuring a sealed waterproof design, adjustable mounting locations and a secure threaded electrical connection. Continuous power rated to 60 amps.

**MKR-28**



### › AC Power Port

Our convenient adapter allows quick thru-hull connection to an AC extension cord using the male AC plug from any of our chargers. No cutting or splicing required. The watertight cover and gasket prevent corrosion on the AC plug when it isn't in use.

**MKR-21** (Freshwater)

**MKR-23** (Saltwater)



### › Trolling Motor Quick Connect

For wiring where a plug and socket cannot be used. Heavy-duty 10-gauge connectors.

**MKR-12**



**NEW**

### Circuit Breaker

Protects trolling motor from electrical damage. 60 amp rating with manual reset. Fully waterproof. Compatible with all 12-, 24- and 36-volt systems, and rated up to 48 volts.

**MKR-27**



### Charger Output Extension Cables

Extension cables are ideal when standard charger cables will not reach bow, center or transom battery compartments. Fused (30 amp) positive and negative leads. Available in 15' length.

**MK-EC-15**



### Get the Right Charge to Keep Your Battery Running Longer

Our digitally controlled battery chargers juice your battery up fast and protect it for years of use. Learn more on page 52.



## OTHER ACCESSORIES

These replacements and upgrades are designed to work seamlessly with your motor.

### Handles



MKA-45



MKA-49

#### › Rope and Handle, or Cable and Handle

For Minn Kota cable-steer bow-mount motors, these replacement handles feature an ergonomic soft-grip design. Choose durable, abrasion resistant 48" nylon rope (MKA-45) or our premium, ultra-strong, abrasion-resistant, coated stainless steel braided cable (MKA-49).



MKA-43  
25"



MKA-44  
40"

#### › Telescopic Extension Handles

Simply twist the handle to loosen, adjust and tighten our extension handles. Go from 17" to 25" (MKA-43) or 24" to 40" (MKA-44) and experience total speed and steering control in any situation. Fits all outboard and trolling motors.



MKA-18  
18"



MKA-7  
30"

#### › Extension Handles

Provides easier steering and speed control for all hand control motors. Available in 18" (MKA-18) or extra-long 30" (MKA-7) models.

### Replacement Remotes



For Terrova and  
Riptide Terrova



For PowerDrive and  
Riptide PowerDrive

#### › CoPilot Replacement Remotes

Control prop on/off, speed and steering on your CoPilot-equipped motor. Terrova/Riptide Terrova version adds high-speed bypass and AutoPilot control.

Note: Neck lanyard not included with replacement remote.

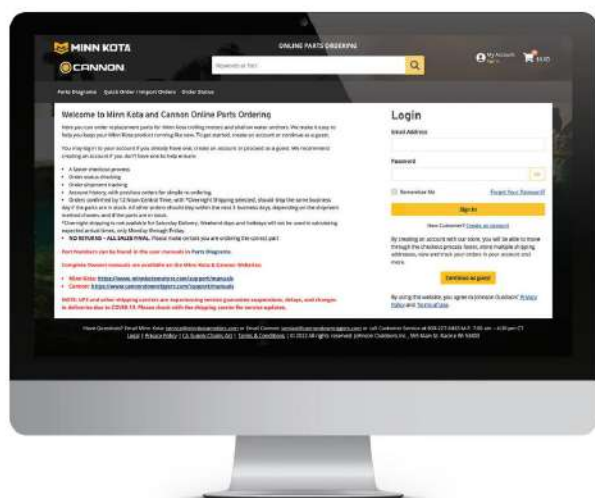

## ORDER PARTS ONLINE

DIY repair is easier than ever thanks to our online parts ordering site. Find what you need for your Minn Kota product and have it shipped directly to you.

[minnkotamotors.com/parts](http://minnkotamotors.com/parts)

### Replacement Foot Pedals



**1866080**

#### ▶ Ulterra and Riptide Ulterra Corded Foot Pedal

Activate Auto Stow/Deploy and Power Trim, Spot-Lock, AutoPilot, speed, steering (heel/toe or left/right), and momentary/constant on. Waterproof design with 18' cord.



**1866070**

#### ▶ PowerDrive and Riptide PowerDrive Corded Foot Pedal\*

Control speed, steering and momentary/constant on. Waterproof design with 18' cord. Compatible with regular and V2 motors, and those equipped with CoPilot™. Not compatible with i-Pilot equipped motors.



**1866076**

#### ▶ Terrova and Riptide Terrova Corded Foot Pedal\*

Activate Spot-Lock, AutoPilot, speed, steering (heel/toe or left/right) and momentary/constant on. Waterproof design with 18' cord. Works with CoPilot, i-Pilot and i-Pilot Link. Compatible with 2017 and later models only.

\* See minnkotamotors.com for additional legacy product accessories.

### Props and Prop Accessories



#### ▶ Weedless Wedge™ 2 Props

Swept-back and flared blades push weeds away even better than the original Weedless Wedge™. Delivers improved efficiency through the heaviest vegetation, at any speed.

**MKP-32, MKP-33, MKP-38**



#### ▶ Weedless Wedge Props

100% weedless. Unique, patented design pushes weeds away to conserve battery power. Easily moves through heavy vegetation, even at slow speeds.

**MKP-6, MKP-7**



#### ▶ Power Props

Delivers extra power to push through heavy vegetation. Fits 3-1/4" (MKP-2) and 3-5/8" (MKP-37) diameters.

**MKP-2, MKP-37**



**MKP-9**

**MKP-34**

#### ▶ Prop Nut Kits

Easy-to-use kit that allows for fast removal/replacement of prop. Available in three different sizes to fit Minn Kota prop dimensions (3/8", 1/2" and 5/16"). Requires crescent wrench for installation.

**MKP-9, MKP-10, MKP-23, MKP-34**



#### ▶ Transducer Mounting Kit

Allows mounting on lower unit of bow- or transom-mount motors. Rugged, durable construction. Fits transducers of all major manufacturers.

**MKR-15**



## DECKHAND™ ELECTRONIC ANCHOR WINCHES

DeckHand™ automatically raises and lowers your anchor at the touch of a button, with a special anti-drag system that senses the bottom to allow for controlled drifting.

**2** YEAR WARRANTY



### DeckHand 40

Our highest-capacity model, featuring a universal davit to stow anchor horizontally and eliminate anchor swing – plus a shackle for quick anchor changes.



### DeckHand 25R

Take remote control of your DeckHand with a 12' corded remote.



### DeckHand 25

An everyday workhorse that's reliable and easy to control.



### DeckHand Pontoon

Easy to mount and remove, thanks to the included Quick Release Bracket (MKA-16-03) and Quick Connect Plug (MKR-20).

	DECKHAND 40	DECKHAND 25R	DECKHAND 25	DECKHAND PONTOON
<b>POWER</b>	12V	12V	12V	12V
<b>ANCHOR CAPACITY</b> (anchor not included)	40-POUND	25-POUND	25-POUND	40-POUND
<b>ANCHOR STOWING DAVIT</b>	X	X	X	-
<b>PRE-SPOOLED WITH 800-POUND TEST NYLON ROPE</b>	100 FEET	60 FEET	60 FEET	-
<b>CONTROL</b>	ON-UNIT SWITCH (remote switch optional)	12' CORDED REMOTE	ON-UNIT SWITCH	DECKHAND 40 REMOTE SWITCH



Operate DeckHand from anywhere with this 25' corded remote switch – optional on DeckHand 40 and comes standard on DeckHand Pontoon.



### DRIFT SOCK

Optimize your bait presentation by slowing down your drift over suspended fish. Features durable construction and – on our MKA-27 – built-in weights and floats that allow it to automatically open when placed in the water.

#### MKA-26

- 34" deep x 22" diameter
- 210 denier ripstop nylon
- Four heavy-duty 1" nylon straps
- 1" wide yellow pull strap for easy retrieval

#### MKA-27

- 34" deep x 22" diameter
- 420 denier ripstop nylon
- Four heavy-duty 1" nylon straps
- 1" wide yellow pull strap for easy retrieval



Drift Sock works against wind and current to improve bait presentation over holding fish.



#### MKA-28: Drift Sock Harness

- 7' length
- 12" sewn loop attaches to any cleat
- Quick connect clip
- Float allows sock to be quickly released to prevent tangles when fighting/landing fish

# GEAR UP. HEAD OUT.



SCAN TO  
SHOP NOW

## APPAREL //////////////

We're always adding new items to our apparel store, including t-shirts, caps, decals and more. See it all and order your favorites at [jofishingapparel.com/minnkota](http://jofishingapparel.com/minnkota).





**MINN KOTA  
TECHNICAL SUPPORT**

P.O. Box 8129  
Mankato, MN 56002  
121 Power Drive  
Mankato, MN 56001  
Phone (800) 227-6433  
Fax (800) 527-4464

**DEALER &  
DISTRIBUTOR SERVICE**

555 Main Street, Suite 241  
Racine, WI 53403  
Phone (800) 493-6686  
Fax (800) 451-0387  
Fax (262) 631-6609

**JOHNSON OUTDOORS INC.  
CANADA**

4180 Harvesters Road  
Burlington, Ontario L7L 6B6  
Phone (905) 634-0023  
Fax (905) 634-0261

AlexChark, Bungeard 360° Forks, MELIX, Himmelsbild, i-Pink, LabelMaster, Moxium, MEGA 360 Imagic, MEGA Downrigger, MEGA Imaging, MEGA Live Imaging, MEGA Star Imaging, Minn Kota One-Box Network, ONX, Roblox, S-DUX, Sport-Box, T-Terra, Triaxx and Ultra are registered trademarks of Johnson Outdoors Marine Electronics, Inc.  
APEX, AutoPilot, Boat Power, Control, DockHound, DualScan PLUS, Endura, Link, Navigator, MicroTouch, Minn Kota Matched Systems, PowerDrive, Quiet Power, TargetLock, The Tread Tiller, Ultimate Power, Ultra and Wireless Wedge are trademarks of Johnson Outdoors Marine Electronics, Inc.  
Android is a trademark of Google LLC.

Apple is a registered trademark of Apple Inc.  
Bluetooth is a registered trademark of Bluetooth SIG, Inc.  
Gemma is a registered trademark of Garmin International Inc.  
LoranC is a registered trademark of Loranco Electronics Inc.  
Specifications are subject to change without notice.  
©2020-2023 Johnson Outdoors Marine Electronics, Inc. All Rights Reserved  
Printed in the USA.



Johnson Outdoors Marine Electronics, Inc. | 121 Power Drive | Mankato, MN 56001  
minnkotamotors.com

